



ARCHITECTURAL PLANNING GUIDE

REDEFINING ELEVATOR TECHNOLOGY

Deliver a user experience that inspires, informs, and delights. With KONE MonoSpace DX elevators you can harness the power of digitalization to take the elevator journey far beyond the ordinary.

Our goal is to create a user experience that both adds value to a building and maximizes comfort and safety for passengers.

Not only are our elevators now enabled with connectivity, we enhanced our elevator offering, so low, mid, and high rise buildings can take advantage of our technology. Our KONE MonoSpace 500 DX solution is enhanced to go higher and faster*.

KONE ECO-EFFICIENT SOLUTIONS

1 A green hoisting system

The KONE EcoDisc permanent-magnet synchronous motor, together with a vector-controlled drive system and regenerative options, delivers eco-efficient operation for every KONE DX elevator.

2 Regenerative drive

Regenerative drive technology recycles energy for immediate reuse within a building and can cut elevator energy consumption by up to 20%.**

3 Standby solutions

Lights, signalization and ventilation can consume a considerable amount of electricity even when the elevator is not moving. KONE's standby solutions cut energy consumption by powering down the equipment when it's not in use.

4 Eco-efficient car lighting

LED lighting is up to 80% more efficient and lasts up to 10 times longer than halogen lighting.



*Greater travel and speeds equal to or greater than 500 FPM available up to 3500 LBS in passenger elevator cars.

** Calculation based on the following: 3,500 lb. capacity, 350 fpm, 7 landings, 72 feet of travel and 200,000 starts per year.

KONE ELEVATORS

KONE MonoSpace® 300 DX

Application	Low rise
Type	Machine room-less
Powered by	KONE EcoDisc
Capacity	2000 - 3500 lbs. (907 - 1588kg)
Speed	150 fpm (.75 m/s)
Landings	2 to 4

The KONE MonoSpace 300 DX is a cost-effective elevator solution for low-rise buildings. It is durable, provides a wide range of cab interiors, stylish accessories, and easy to use signalization.

KONE MonoSpace® 500 DX

Application	Low- to mid-rise; new buildings
Type	Machine room-less
Powered by	KONE EcoDisc
Capacity	2000 – 5000 AIA lbs. (907 – 2268 kg)
Speed	150, 200, 350, 500* fpm (.75, 1.0, 1.78, 2.54 m/s)
Landings	5 to 36

The KONE MonoSpace 500 DX combines our proven eco-efficient technology with ride-comfort and design innovations.

*Greater travel and speeds equal to or greater than 500 FPM available up to 3500 LBS in passenger elevator cars.

KONE MonoSpace® Flex DX

Application	Low- to mid-rise; existing buildings
Type	Machine room-less
Powered by	KONE EcoDisc
Capacity	2000 – 5000 AIA lbs. (907 – 2268 kg)
Speed	150, 200, 350 fpm (.75, 1.0, 1.78 m/s)
Landings	2 to 15
Entrances	Option to reuse existing entrances
Flexible Platforms	With accommodation of reduced overhead dimension

KONE MonoSpace Flex DX is a turnkey full-replacement elevator solution for existing hydraulic and traction elevator systems.

KONE MonoSpace® 700 DX

Application	Mid- to high-rise
Type	Machine room-less
Powered by	KONE EcoDisc
Capacity	2000 – 5000 AIA lbs. (907 – 2268 kg)
Speed	200, 350, 500 fpm (1.00, 1.78, 2.54 m/s)
Landings	6 to 36

KONE MonoSpace 700 DX is a fully customizable machine room-less solution for mid- to high-rise applications.

KONE MiniSpace™ DX

Application	Mid- to high-rise
Type	Overhead machine room
Powered by	KONE EcoDisc
Capacity	2000 – 5000 AIA lbs. (907 – 2268 kg)
Speed	200, 350, 400, 500, 700 fpm (1.00, 1.78, 2.00, 2.54, 3.56 m/s)
Landings	6 to 63

KONE MiniSpace DX is an innovative, space efficient, mid-to high-rise solution.

KONE MONOSPACE[®] 300 DX

CONFIGURATIONS & DIMENSIONS

Max Travel⁽⁸⁾ 48 ft. (14.6 m)

Speed⁽⁸⁾
150 fpm
(.75 m/s)

Car Height (F)
7 ft. 6 in.
(2286 mm)

Entrance Height (G)
7 ft.
(2134 mm)

Max Landings 4

			(A)	(A) SEISMIC	(B)	(B) SEISMIC	(C)	(D)	(E)	
		CAPACITY LBS. (kg)	HOISTWAY WIDTH (mm)	HOISTWAY WIDTH (mm)	HOISTWAY DEPTH (mm)	HOISTWAY DEPTH (mm)	INTERIOR WIDTH (mm)	INTERIOR DEPTH (mm)	DOOR WIDTH (mm)	STRETCHER ACCOMMODATION ⁽⁹⁾
FRONT OPENING PASSENGER	2000 (907)	Side Opening	7'-4" (2235)	7'-9" (2362)	5'-9" (1753)	5'-9 1/2" (1766)	5'-8 7/8" (1750)	4'-4 7/16" (1332)	3'-0" (914)	NO
	2500 (1134)	Side Opening or Center Opening	8'-4" (2540)	8'-9" (2667)	5'-9" (1753)	5'-9 1/2" (1766)	6'-8 7/8" (2055)	4'-4 7/16" (1332)	3'-6" (1067)	NO
	3000 (1361)	Side Opening or Center Opening	8'-4" (2540)	8'-7" (2616)	6'-3" (1905)	6'-3 1/2" (1918)	6'-5 5/8" (1971)	5'-0 7/16" (1536)	3'-6" (1067)	NO
	3500 (1588)	Side Opening or Center Opening	8'-4" (2540)	8'-7" (2616)	6'-11" (2108)	6'-11" (2108)	6'-5 5/8" (1971)	5'-6 5/8" (1693)	3'-6" (1067)	YES ⁽⁹⁾
FRONT & REVERSE OPENING PASSENGER	2000 (907)	Side Opening	7'-4" (2235)	7'-9" (2362)	6'-3 3/4" (1924)	6'-3 3/4" (1924)	5'-8 7/8" (1750)	4'-4 7/16" (1332)	3'-0" (914)	NO
	2500 (1134)	Side Opening or Center Opening	8'-4" (2540)	8'-9" (2667)	6'-3 3/4" (1924)	6'-3 3/4" (1924)	6'-8 7/8" (2055)	4'-4 7/16" (1332)	3'-6" (1067)	NO
	3000 (1361)	Side Opening or Center Opening	8'-4" (2540)	8'-7" (2616)	6'-11 3/4" (2127)	6'-11 3/4" (2127)	6'-5 5/8" (1971)	5'-0 7/16" (1536)	3'-6" (1067)	NO
	3500 (1588)	Side Opening or Center Opening	8'-4" (2540)	8'-7" (2616)	7'-6" (2286)	7'-6" (2284)	6'-5 5/8" (1971)	5'-6 5/8" (1693)	3'-6" (1067)	NO

CLEAR OVERHEAD (H) AND PIT DEPTH (I)			CONTROL SPACE		(J)	(K)	(L)
CAPACITY LBS. (kg)	150 FPM (.75 m/s)		CAPACITY LBS. (kg)	CONTROLLER SPACE	WIDTH (mm)	DEPTH (mm)	DOOR WIDTH (mm)
	Pit Depth (mm)	Clear Overhead (mm)					
2000 to 3500 (907 to 1588)	5'-0" (1524)	11'-8" (3556) ⁽¹⁾	2000 to 3500 (907 to 1588)	Remote Closet	4'-1" (1245)	1'-8" (508)	3'-6" (1067)
2000 to 3500 (907 to 1588)			2000 to 3500 (907 to 1588)	Adjacent or Remote Room	5'-0" (1524)	Dimension (B)	3'-0" (914)

Visit kone.us for the latest project-specific details, CAD drawings, BIM models, CSI specifications, electrical data, reaction loads and building access requirements.

Notes

- An 8" inch tall hoist beam is required for installation (by others). Dimension (H) reflects 11'-8" clearance under hoist beam. This clearance is available with a moveable hoist beam.
- If an EBD (Emergency Battery Device) is required please contact your KONE Sales Professional for further detail regarding dimensions, (J) and (L).
- The published hoistway (A) dimensions represent the minimum clear inside requirements. Construction efficiencies can be realized by increasing these dimensions by up to 2" (51 mm).
- For pit depths less than 5' (1524 mm) please contact a KONE Sales Professional.
- The published interior width (C) and depth (D) dimensions represent the minimum clear inside requirements without raised panels. For interior width (C) and Depth (D) dimensions with raised panels please contact a KONE sales Professional.
- A pit ladder wall pocket may be required. Please contact a KONE sales Professional.
- Contact your local KONE Sales Professional regarding local code variations when utilizing the integrated remote closet options.
- If IBC (International Building Code) 2018 or ASME A17.1-2019/CSA B44-19 code is applicable, contact your local sales professional for controller space configurations.
- Stretcher accessibility based only for side opening type and International / California Building Code specified 24 inch by 84 inch stretcher with 5 inch degree radius corners. Customers in Canada, please review stretcher compliance with your local sales representatives.
- All KONE MonoSpace 300 DX elevators utilize a single speed door.

Plan Views

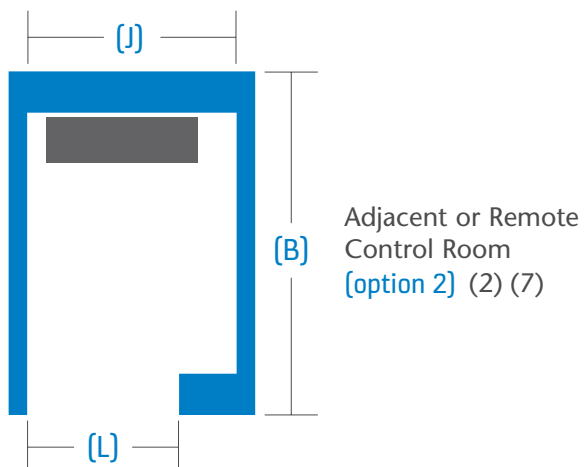
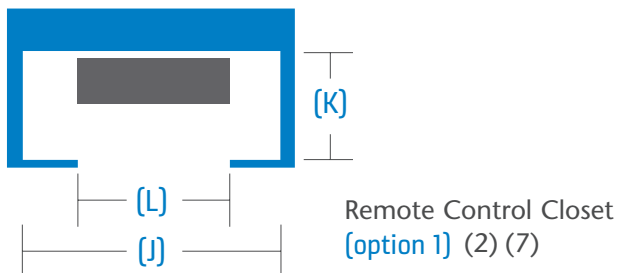
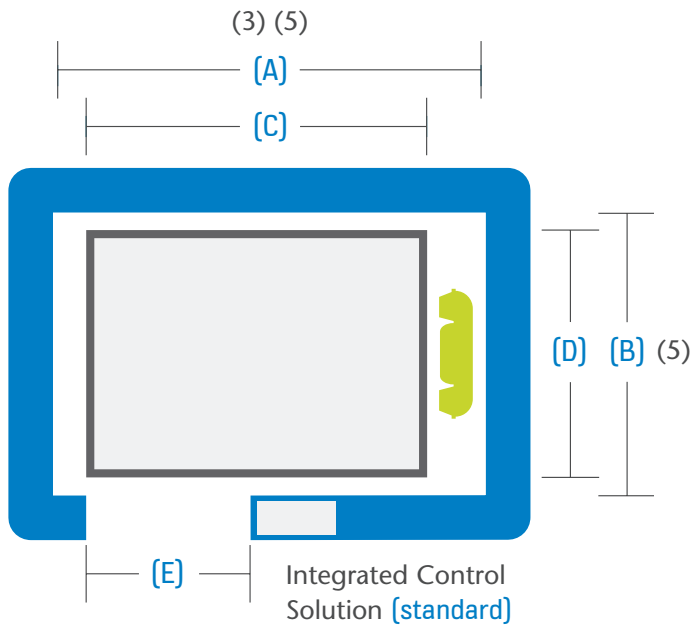

Section View

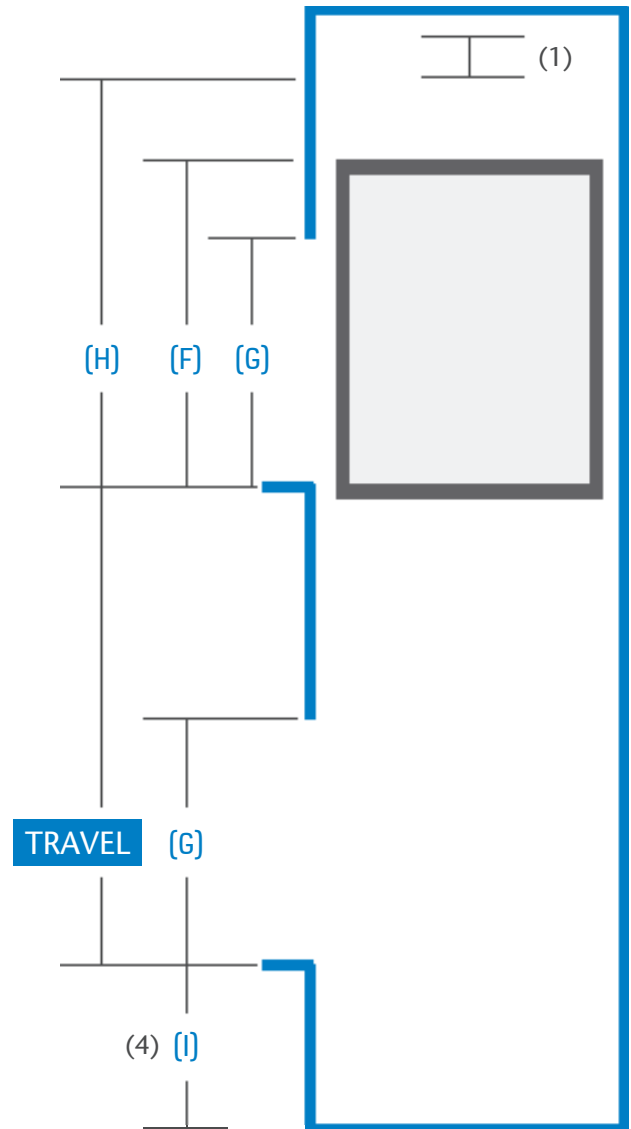

KONE MONOSPACE® 500 DX

CONFIGURATIONS & DIMENSIONS

Max Travel⁽⁸⁾ 150 ft. (45.7 m)

Speed⁽⁸⁾

150, 200, 350 fpm
(.75, 1.0, 1.78 m/s)

Car Height (F)

8, 9 or 10 ft.
(2438, 2743 or 3048 mm)

Entrance Height (G)

7, 8 or 9 ft.
(2134, 2438 or 2743 mm)

		[A]	[A] SEISMIC	[B]	[B] SEISMIC	[C]	[D]	[E]			
		CAPACITY LBS. (kg)	OPENING TYPE ¹	HOISTWAY WIDTH (mm)	HOISTWAY WIDTH (mm)	HOISTWAY DEPTH (mm)	HOISTWAY DEPTH (mm)	INTERIOR WIDTH (mm)	INTERIOR DEPTH (mm)	DOOR WIDTH (mm)	STRETCHER ACCOMMODATION ⁽¹⁰⁾
FRONT OPENING	PASSENGER	2000 (907)	SSP	7'-6" (2286)	7'-11" (2413)	5'-9" (1753)	5'-9 1/2" (1766)	5'-8 7/8" (1750)	4'-4 7/8" (1332)	3'-0" (914)	No
		2500 (1134)	SSP / CO	8'-6" (2591)	8'-11" (2718)	5'-9" (1753)	5'-9 1/2" (1766)	6'-8 7/8" (2055)	4'-4 7/8" (1332)	3'-6" (1067)	No
		2500 IBC (1134) ⁽¹⁰⁾	SSP	8'-11" (2718)	9'-5" (2870)	5'-9" (1753)	5'-9 1/2" (1766)	6'-11 3/4" (2128)	4'-4 7/8" (1332)	3'-6" (1067)	Yes
		3000 (1361)	SSP / CO	8'-6" (2591)	8'-9" (2667)	6'-3" (1905)	6'-3 1/2" (1918)	6'-5 3/8" (1971)	5'-0 7/8" (1536)	3'-6" (1067)	No
		3500 (1588)	SSP / CO	8'-6" (2591)	8'-9" (2667)	6'-11" (2108)	6'-11" (2108)	6'-5 3/8" (1971)	5'-6 3/8" (1693)	3'-6" (1067)	Yes
	4000 (1814)	CO	9'-8" (2947)	9'-8" (2947)	6'-11" (2108)	6'-11" (2108)	7'-6 1/8" (2304)	5'-6 3/8" (1693)	4'-0" (1219)	Yes	
	4000 (1814)	2SP	7'-8" (2337)	7'-8" (2337)	9'-2" (2794)	9'-2" (2794)	5'-7 1/8" (1705)	7'-7 7/8" (2334)	4'-0" (1219)	Yes	
	4500 (2041)	2SP	7'-8" (2337)	7'-8" (2337)	9'-8" (2946)	9'-8" (2946)	5'-7 1/8" (1705)	8'-1 1/8" (2486)	4'-0" (1219)	Yes	
	5000 (2268) ⁽⁹⁾	2SP	7'-10" (2388)	7'-10" (2388)	10'-2 1/2" (3112)	10'-2 1/2" (3112)	5'-7 1/8" (1705)	8'-9 1/8" (2685)	4'-6" (1372) ⁽⁹⁾	Yes	
	5000 AIA (2268)	2SP	7'-10 3/16" (2396)	7'-11 1/2" (2426)	10'-5 1/16" (3177)	10'-5 1/16" (3177)	5'-9 7/16" (1764)	9'-0 7/16" (2755)	4'-6" (1372) ⁽⁹⁾	Yes	
FRONT & REVERSE OPENING	PASSENGER	2000 (907)	SSP	7'-6" (2286)	7'-11" (2413)	6'-3 3/4" (1924)	6'-3 3/4" (1924)	5'-8 7/8" (1750)	4'-4 7/8" (1332)	3'-0" (914)	No
		2500 (1134)	SSP / CO	8'-6" (2591)	8'-11" (2718)	6'-3 3/4" (1924)	6'-3 3/4" (1924)	6'-8 7/8" (2055)	4'-4 7/8" (1332)	3'-6" (1067)	No
		2500 IBC (1134) ⁽¹⁰⁾	SSP	8'-11" (2718)	9'-5" (2870)	6'-3 3/4" (1924)	6'-3 3/4" (1924)	6'-11 3/4" (2128)	4'-4 7/8" (1332)	3'-6" (1067)	Yes
		3000 (1361)	SSP / CO	8'-6" (2591)	8'-9" (2667)	6'-11 3/4" (2127)	6'-11 3/4" (2127)	6'-5 3/8" (1971)	5'-0 7/8" (1536)	3'-6" (1067)	No
		3500 (1588) ⁽¹⁰⁾	SSP / CO	8'-6" (2591)	8'-9" (2667)	7'-6" (2286)	7'-6" (2286)	6'-5 3/8" (1971)	5'-6 3/8" (1693)	3'-6" (1067)	Yes*
	4000 (1814)	CO	9'-8" (2947)	9'-8" (2947)	7'-6" (2286)	7'-6" (2286)	7'-6 1/8" (2304)	5'-6 3/8" (1693)	4'-0" (1219)	Yes	
	4000 (1814)	2SP	7'-8" (2337)	7'-8" (2337)	10'-2 1/8" (3102)	10'-2 1/8" (3102)	5'-7 1/8" (1705)	7'-7 7/8" (2334)	4'-0" (1219)	Yes	
	4500 (2041)	2SP	7'-8" (2337)	7'-8" (2337)	10'-8 1/8" (3252)	10'-8 1/8" (3252)	5'-7 1/8" (1705)	8'-1 1/8" (2486)	4'-0" (1219)	Yes	
	5000 (2268) ⁽⁹⁾	2SP	7'-10" (2388)	7'-10" (2388)	11'-3 3/8" (3451)	11'-3 3/8" (3451)	5'-7 1/8" (1705)	8'-9 1/8" (2685)	4'-6" (1372) ⁽⁹⁾	Yes	
	5000 AIA (2268)	2SP	7'-10 3/16" (2396)	7'-11 1/2" (2426)	11'-6 1/16" (3522)	11'-6 1/16" (3522)	5'-9 7/16" (1764)	9'-0 7/16" (2755)	4'-6" (1372) ⁽⁹⁾	Yes	

† SSP = Single Speed Side Opening / CO = Single Speed Center Opening / 2SP = Two Speed Side Opening

CAPACITY LBS. (kg)	CLEAR OVERHEAD (H) AND PIT DEPTH (I)					
	150 FPM (0.75 M/S)		200 FPM (1.00 M/S)		350 FPM (1.78 M/S)	
	PIT DEPTH (mm)	CLEAR OVERHEAD (mm)	PIT DEPTH (mm)	CLEAR OVERHEAD (mm)	PIT DEPTH (mm)	CLEAR OVERHEAD (mm)
2000 to 2500 (907 to 1134)	5'-0" (1524)	13'-0" (3962)	5'-0" (1524)	13'-4" (4064)	5'-6" (1676)	13'-6" (4115)
3000 to 3500 (1361 to 1588)	5'-0" (1524)	13'-0" (3962)	5'-0" (1524)	13'-4" (4064)	5'-6" (1676)	13'-6" (4115)
4000 to 5000 AIA (1814 to 2268)	5'-0" (1524)	13'-8" (4166)	5'-0" (1524)	13'-8" (4166)	5'-6" (1676)	13'-8" (4166)

Visit kone.us for the latest project-specific details, CAD drawings, BIM models, CSI specifications, electrical data, reaction loads and building access requirements.

CONTROL SPACE ⁽¹¹⁾	[J]	[K]	[L]	
CAPACITY LBS. (kg)	CONTROLLER SPACE	WIDTH (mm)	DEPTH (mm)	DOOR WIDTH (mm)
2000 to 5000 AIA (907 to 2268)	Remote Room	4'-1" (1245) ⁽¹¹⁾	1'-8" (508) ⁽¹¹⁾	3'-6" (1067) ⁽¹¹⁾
2000 to 5000 AIA (907 to 2268)	Adjacent or Remote Room	5'-0" (1524)	Dimension [B]	3'-0" (914) ⁽¹¹⁾

Notes

- A hoist beam (by KONE) is required for installation (by others). Dimension [H] reflects clear under hoist beam.
- If an Emergency Battery Device (EBO) is required, please contact your KONE Sales Professional for further detail regarding dimensions [H], [J] and [L].
- The published [A] hoistway dimension represents the optimum clear inside requirements and maybe reduced by up to 2" (51mm). However, this may result in construction inefficiencies.
- The published interior width [C] and depth [D] dimensions represent the minimum clear inside requirements without raised panels. For interior width [C] and depth [D] dimensions with raised panels please contact a KONE Sales Professional.
- 2500 LB. IBC (International Building Code) reverse opening must be diagonally opposed. For all other front and reverse opening configurations, hoistway width [A] is valid for directly opposed openings only. If diagonally opposed openings are required, please contact your KONE Sales Professional.
- The published minimum pit depth [I] dimension is based upon slide guides. For minimum pit depth [I] with roller guides please contact a KONE Sales Professional.
- All dimensions are based on an 8'-0" (2438 mm) cab with a 7'-0" (2134 mm) door. Alternate car and door heights are available, but will affect dimension [H].
- 150 fpm (.75 m/s) only available up to 85 ft. (25 m) of travel and 10 landings. 200 fpm (1.00 m/s) available up to 100 ft. (30.5 m) of travel and 12 landings.
- 4'-0" (1219 mm) door width also available.
- Stretcher accessibility based on international building code (IBC) and California Building Code specified, 24 inch by 84 inch stretcher - with 5-inch radius corners. Elevator car must utilize a side slide door with the exception of the 4000 LB. passenger shaped car. In Canada (NBCC) 2500 LB. and larger elevators with single slide doors meet Canadian stretcher rule of 2010mm x 610mm.
- If IBC (International Building Code) 2018 or ASME A17.1-2019/CSA B44-19 code is applicable, contact your local sales professional for controller space configurations.

* 3,500 LB. Front / reverse elevators needs to have diagonal opposed doors and a wider hoistway width of 8' -9" (8' -11" if seismic) to accommodate a stretcher. Please contact a KONE Sales Professional for more information.

Plan Views

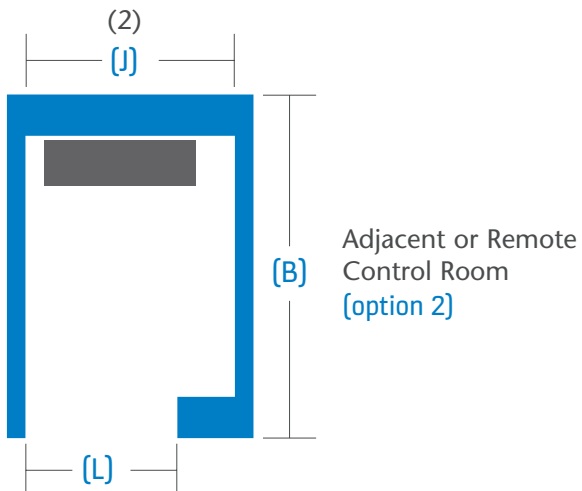
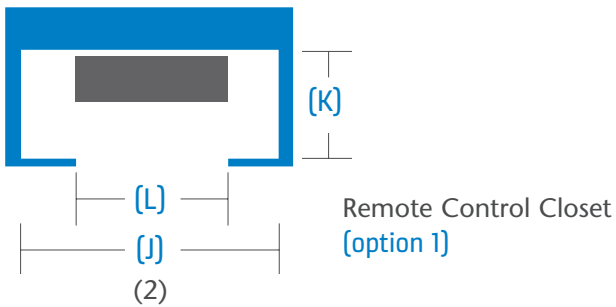
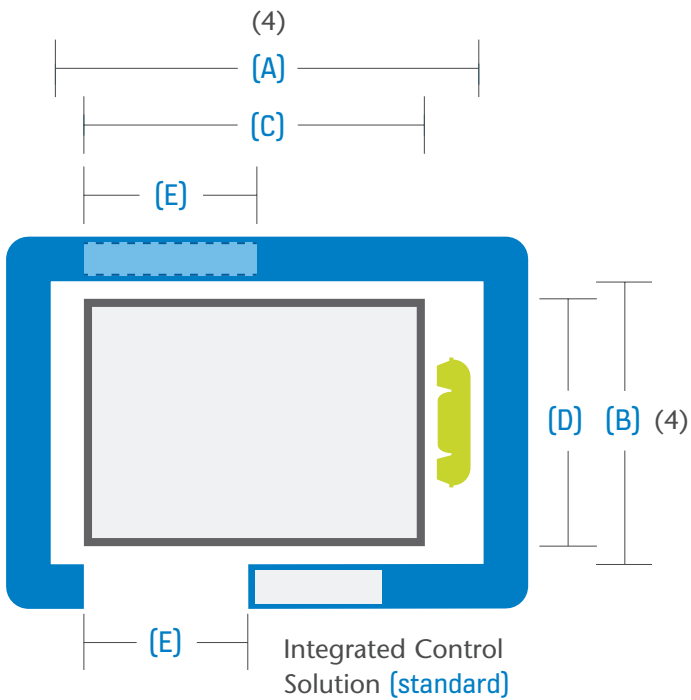

Section View

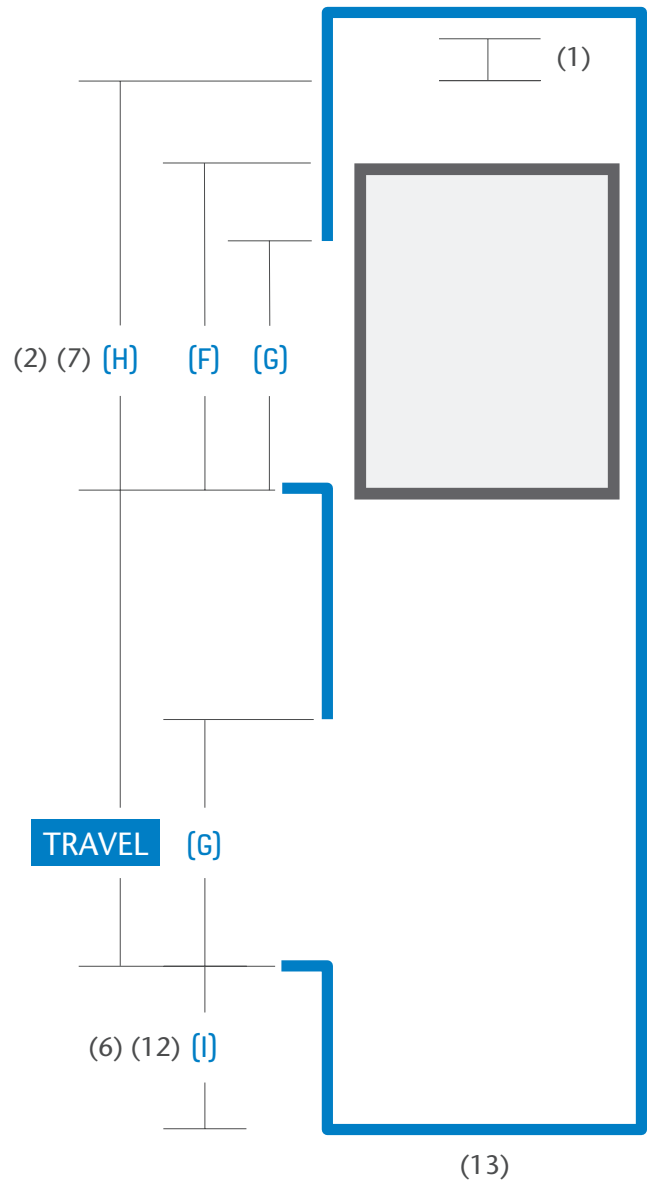

Notes, continued:

Please consult a KONE Sales Professional regarding:

- (12) Pit depths less than 5'-0" (1524 mm).
- (13) Occupied space beneath the hoistway.
- (14) Local code variations when utilizing the integrated, integral and remote closet options.

KONE MONOSPACE® 500 DX

CONFIGURATIONS & DIMENSIONS

Max Travel 350 ft. (106.7 m)

Speed

500, 700 fpm
(2.54, 3.55 m/s)

Car Height (F)

8, 9 or 10 ft.
(2438, 2743 or 3048 mm)

Entrance Height (G)

7, 8 or 9 ft.
(2134, 2438 or 2743 mm)

			(A)	(A) SEISMIC	(B)	(B) SEISMIC	(C)	(D)	(E)		
		CAPACITY LBS. (kg)	OPENING TYPE†	HOISTWAY WIDTH (mm)	HOISTWAY WIDTH (mm)	HOISTWAY DEPTH (mm)	HOISTWAY DEPTH (mm)	INTERIOR WIDTH (mm)	INTERIOR DEPTH (mm)	DOOR WIDTH (mm)	STRETCHER ACCOMMODATION ⁽⁷⁾
FRONT OPENING	PASSENGER	2000 (907)	SSP	8'-1 1/4" (2472)	8'-3 5/8" (2531)	5'-11 5/8" (1821)	6'-0 1/2" (1843)	5'-8 7/8" (1750)	4'-4 7/8" (1332)	3'-0" (914)	No
		2500 (1134)	SSP / CO	9'-1 3/8" (2777)	9'-3 5/8" (2835)	5'-11 5/8" (1821)	6'-0 1/2" (1843)	6'-8 7/8" (2055)	4'-4 7/8" (1332)	3'-6" (1067)	No
		2500 IBC (1134) ⁽⁷⁾	SSP	9'-4 1/8" (2849)	9'-6 1/2" (2908)	5'-11 5/8" (1821)	6'-0 1/2" (1843)	6'-11 3/4" (2128)	4'-4 7/8" (1332)	3'-6" (1067)	Yes
		3000 (1361)	SSP / CO	8'-10" (2693)	9'-0" (2743)	6'-8 1/8" (2035)	6'-9" (2057)	6'-5 3/8" (1971)	5'-0 3/8" (1536)	3'-6" (1067)	No
		3500 (1588)	SSP / CO	8'-10" (2693)	9'-0" (2743)	7'-3" (2210)	7'-4" (2235)	6'-5 3/8" (1971)	5'-6 3/8" (1693)	3'-6" (1067)	Yes
		4000 (1814)	CO	9'-11 1/8" (3026)	10'-0 3/4" (3068)	7'-3" (2210)	7'-4" (2235)	7'-6 1/8" (2304)	5'-6 3/8" (1693)	4'-0" (1219)	Yes
FRONT & REVERSE OPENING	PASSENGER	2000 (907)	SSP	8'-1 1/4" (2472)	8'-3 5/8" (2531)	6'-3 3/4" (1924)	6'-3 3/4" (1924)	5'-8 7/8" (1750)	4'-4 7/8" (1332)	3'-0" (914)	No
		2500 (1134)	SSP / CO	9'-1 3/8" (2777)	9'-3 5/8" (2835)	6'-3 3/4" (1924)	6'-3 3/4" (1924)	6'-8 7/8" (2055)	4'-4 7/8" (1332)	3'-6" (1067)	No
		2500 IBC (1134) ⁽⁹⁾⁽⁷⁾	SSP	9'-4 1/8" (2848)	9'-6 1/2" (2908)	6'-3 3/4" (1924)	6'-3 3/4" (1924)	6'-11 3/4" (2128)	4'-4 7/8" (1332)	3'-6" (1067)	Yes
		3000 (1361)	SSP / CO	8'-10" (2693)	9'-0" (2743)	6'-11 3/4" (2127)	6'-11 3/4" (2127)	6'-5 3/8" (1971)	5'-0 3/8" (1536)	3'-6" (1067)	No
		3500 (1588) ⁽⁷⁾	SSP / CO	8'-10" (2693)	9'-0" (2743)	7'-6" (2286)	7'-6" (2286)	6'-5 3/8" (1971)	5'-6 3/8" (1693)	3'-6" (1067)	Yes*
		4000 (1814)	CO	9'-11 1/8" (3026)	10'-0 3/4" (3068)	7'-6" (2286)	7'-6" (2286)	7'-6 1/8" (2304)	5'-6 3/8" (1693)	4'-0" (1219)	Yes

† SSP = Single Speed Side Opening / CO = Single Speed Center Opening

CLEAR OVERHEAD (H) AND PIT DEPTH (I)	CAPACITY LBS. (kg) FT. (m)			
	500 FPM (2.54 M/S)		700 FPM (3.55 M/S)	
	PIT DEPTH (mm)	CLEAR OVERHD (mm)	PIT DEPTH (mm)	CLEAR OVERHD (mm)
2000 to 3500 ≤ 150 ft (1588) (45.7)	5'-11" (1803)	17'-2" (5232)	9'-8" (2946)	17'-2" (5232)
2000 to 3500 > 150 ft (1588) (45.7)	6'-8" (2032)	17'-2" (5232)	10'-5" (3175)	17'-2" (5232)
4000 ≤ 150 ft (1814) (45.7)	5'-11" (1803)	17'-2" (5232)	-	-
4000 > 150 ft (1814) (45.7)	6'-8" (2032)	17'-2" (5232)	-	-

CAPACITY LBS. (kg)	CONTROL SPACE	(J)	(K)	(L)
		WIDTH (mm)	DEPTH (mm)	DOOR WIDTH (mm)
2000 to 4000 (907 to 1814)	Jamb Mounted Integrated Control Solution ⁽¹²⁾	-	1'-2 1/4" (362)	-
2000 to 4000 (907 to 1814)	Remote Room	4'-1" (1245) ⁽¹¹⁾	1'-8" (508) ⁽¹¹⁾	3'-6" (1067) ⁽¹¹⁾
2000 to 4000 (907 to 1814)	Adjacent or Remote Room	5'-0" (1524)	Dimension (B)	3'-0" (914) ⁽¹¹⁾

Visit kone.us for the latest project-specific details, CAD drawings, BIM models, CSI specifications, electrical data, reaction loads and building access requirements.

Notes

- (1) A hoist beam (by KONE) is required for installation (by others). Dimension (H) reflects clear under hoist beam.
 - (2) If an Emergency Battery Device (EBD) or KONE Destination is required, please contact your KONE Sales Professional for further detail regarding dimensions (J) and (L).
 - (3) The published (A) hoistway dimension represents the optimum clear inside requirements and maybe reduced by up to 2" (51mm). However, this may result in construction inefficiencies.
 - (4) The published interior width (C) and depth (D) dimensions represent the minimum clear inside requirements without raised panels. For interior width (C) and depth (D) dimensions with raised panels please contact a KONE Sales Professional.
 - (5) 2500 LB. IBC reverse opening must be diagonally opposed. For all other front and reverse opening configurations, hoistway width (A) is valid for directly opposed openings only. If diagonally opposed openings are required, please contact your KONE Sales Professional.
 - (6) All dimensions are based on an 8'-0" (2438 mm) cab with a 7'-0" (2134 mm) door. Alternate car and door heights are available, but will affect dimension (H).
 - (7) Stretcher accessibility based on international building code (IBC) and California Building Code specified, 24 inch by 84 inch stretcher — with 5-degree radius corners. Elevator car must utilize a side slide door with the exception of the 4000 LB. passenger shaped car. In Canada (NBCC) 2500 LB. and larger elevators with single slide doors meet Canadian stretcher rule of 2010mm x 610mm.
 - (8) If IBC 2018 or ASME A17.1-2019/CSA B44-19 code is applicable, contact your local sales professional for controller space configurations.
- *3500LB front / reverse elevator needs to have diagonal opposed doors and a 3 inch wider hoistway to accommodate a stretcher. Please add 3 inches to what is shown in the above table. Please contact a KONE Sales Professional for more information.

Plan Views

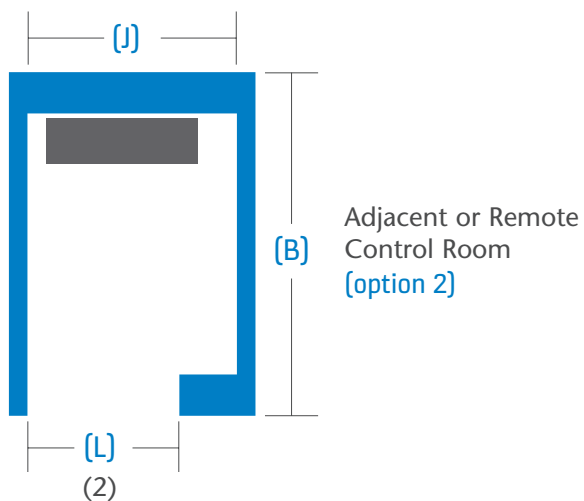
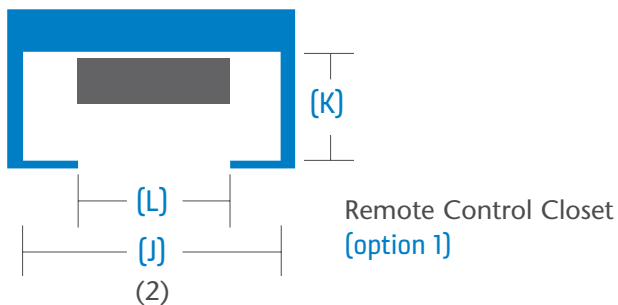
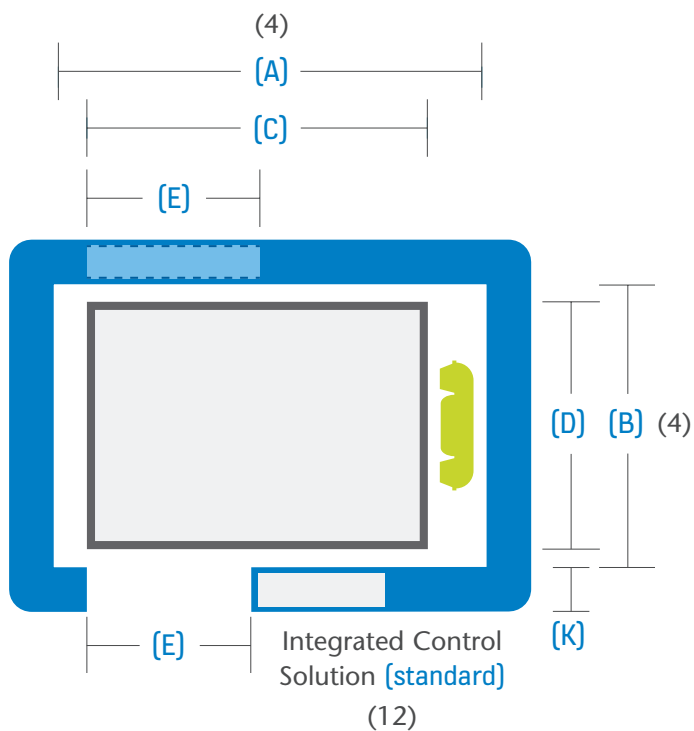

Section View

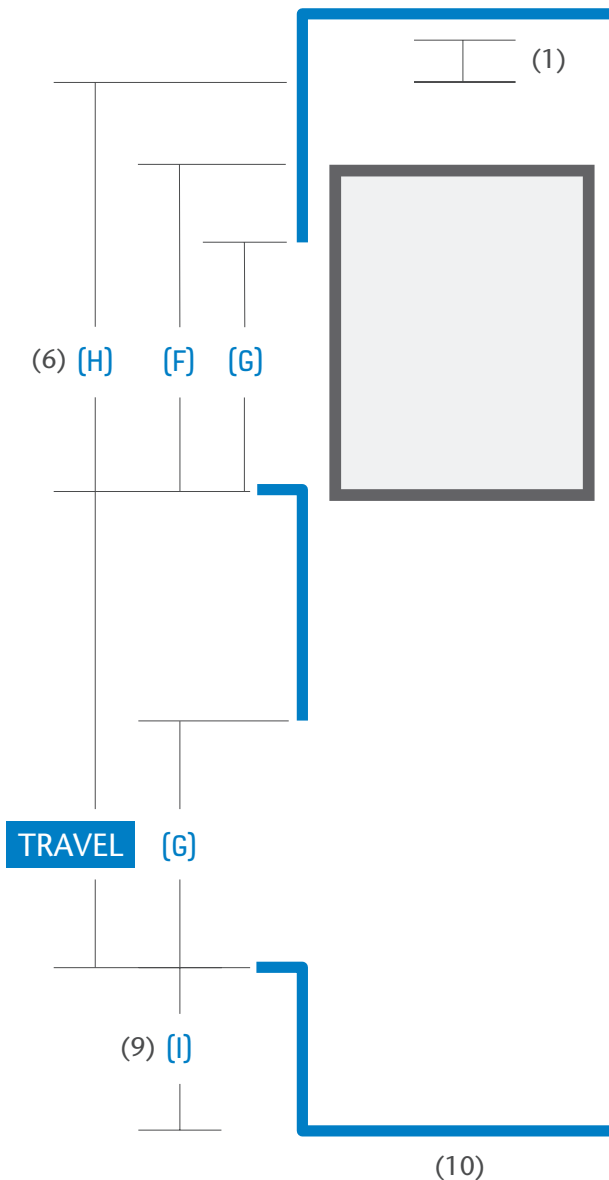

Notes, continued:

Please consult a KONE Sales Professional regarding:

- (9) Smaller pit and overhead dimensions may be available per specific applications.
- (10) Occupied space beneath the hoistway is not allowed.
- (11) Local code variations when utilizing the integrated, integral and remote closet options.
- (12) Integrated Control Solution requires ≥ 460 V3 phase power.

KONE MONOSPACE® FLEX DX

KONE MonoSpace Flex DX is a full replacement elevator solution for existing buildings.

Replacing your elevators

Instead of replacing your aging elevators with similar technology, KONE offers you an advanced, state-of-the-art solution. Our innovative machine room-less design is the first turnkey full replacement elevator solution for existing hydraulic and traction elevator systems. Thanks to the revolutionary KONE EcoDisc® motor, KONE MonoSpace Flex DX is designed to fit into existing hoistways.

From the initial planning stages and site surveys through final completion, KONE works to ensure the entire process is well-planned and streamlined in order to minimize disruption to your building.

KONE MonoSpace Flex DX advantages

- **For the owner:** Minimized building disruption, increased property value, accommodation of reduced overhead dimension.
Building owners who purchase the Integrated Control Solution (ICS) will gain back additional space in their facility, no longer requiring a machine room. Therefore mandatory code related updates for machine room are not needed either. The new space can be used to fit the building owners needs.
- **For the tenant:** Smoother, quieter ride, no hydraulic oil odor, optimum stopping accuracy, sophisticated car features
- **For the environment:** No hydraulic oil, energy-efficient, ability to recycle existing elevator where feasible, option to retain and reuse existing entrances





- 1 Space efficiency**
 With the machine in the hoistway and the controller accessible from the top landing, the space previously needed for a dedicated machine room or control space can be allocated for more profitable uses.
- 2 Energy efficiency**
 In addition to the efficient KONE EcoDisc® hoisting machine, advanced standby solutions save energy by powering down the equipment when it's not in use.
- 3 Minimized disruption**
 The compact design fits inside existing hoistways, minimizing the need for modifications.
- 4 Reusable entrances**
 The ability to interface with most existing entrances reduces the need for significant structural modifications.
- 5 Modern, code-compliant**
 Modern, simple and code-compliant operating displays.
- 6 High performance**
 Passengers enjoy smooth acceleration and deceleration, accurate leveling and a quiet, comfortable ride.
- 7 No oil**
 When applicable, the existing hydraulic cylinder is drained of all oil and capped, ensuring oil-free, environmentally friendly operation.
- 8 Integrated Control Solution (ICS)**
 An integrated control solution is available for units up to 350 FPM and 3500 lb. capacity. Use of ICS allows KONE to return existing machine room space back to the building for ownership's use.
- 9 Destination control**
 The KONE Destination can significantly improve convenience in your building while enhancing the appearance of your lobby. Please consult your KONE Sales Professional.

KONE MONOSPACE[®] 700 DX

MACHINE AT REAR CONFIGURATION & DIMENSIONS

Max Travel 300 ft. (91.4 m)
Max Landings 36

Speed
200, 350, 500 fpm
(1.0, 1.78, 2.54 m/s)

Car Height (F)
8, 9 or 10 ft.
(2438, 2743 or 3048 mm)

Entrance Height (G)
7, 8 or 9 ft.
(2134, 2438 or 2743 mm)

Available in passenger shape with front opening option

FRONT OPENING		(A)	(A) SEISMIC	(B)	(C)	(D)	(E)	
CAPACITY LBS. (kg)	OPENING TYPE†	HOISTWAY WIDTH (mm)	HOISTWAY WIDTH (mm)	HOISTWAY DEPTH (mm)	INTERIOR WIDTH (mm)	INTERIOR DEPTH (mm)	DOOR WIDTH (mm)	
PASSENGER	2000 (907)	SSP	7'-4" (2235)	7'-8" (2337)	6'-8" (2032)	5'-8½" (1740)	4'-3¼" (1302)	3'-0" (914)
	2500 (1134)	SSP / CO	8'-4" (2540)	8'-8" (2642)	6'-8" (2032)	6'-8½" (2045)	4'-3¼" (1302)	3'-6" (1067)
	3000 (1361)	SSP / CO	8'-4" (2540)	8'-8" (2642)	7'-2" (2184)	6'-8½" (2045)	4'-9¼" (1454)	3'-6" (1067)
	3500 (1588)	SSP / CO	8'-4" (2540)	8'-8" (2642)	7'-10" (2388)	6'-8½" (2045)	5'-5¼" (1657)	3'-6" (1067)
	4000 (1814)	CO	9'-4" (2845)	9'-8" (2947)	7'-10" (2388)	7'-8½" (2350)	5'-5¼" (1657)	4'-0" (1219)

† SSP = Single Speed Side Opening / CO = Single Speed Center Opening

CLEAR OVERHEAD (H) AND PIT DEPTH (I)												
CAPACITY LBS. (kg)	200 FPM (1.00 M/S)				350 FPM (1.78 M/S)				500 FPM (2.54 M/S)			
	(I)	(I) SEISMIC	(H)	(H) SEISMIC	(I)	(I) SEISMIC	(H)	(H) SEISMIC	(I)	(I) SEISMIC	(H)	(H) SEISMIC
	PIT DEPTH (mm)	PIT DEPTH (mm)	CLEAR OVERHD (mm)	CLEAR OVERHD (mm)	PIT DEPTH (mm)	PIT DEPTH (mm)	CLEAR OVERHD (mm)	CLEAR OVERHD (mm)	PIT DEPTH (mm)	PIT DEPTH (mm)	CLEAR OVERHD (mm)	CLEAR OVERHD (mm)
2000 (907)	5'-3" (1600)	5'-3" (1600)	15'-6" (4724)	16'-11" (5156)	5'-7" (1702)	6'-7" (2007)	16'-11" (5156)	16'-11" (5156)	5'-7" (1702)	6'-7" (2007)	16'-11" (5156)	16'-11" (5156)
2500 (1134)	5'-3" (1600)	5'-3" (1600)	15'-0" (4572)	16'-11" (5156)	5'-5" (1651)	6'-5" (1956)	16'-7" (5055)	16'-11" (5156)	5'-5" (1651)	6'-5" (1956)	16'-7" (5055)	16'-11" (5156)
3000 (1361)	5'-3" (1600)	5'-3" (1600)	15'-2" (4623)	16'-11" (5156)	5'-5" (1651)	6'-5" (1956)	16'-10" (5131)	16'-11" (5156)	5'-5" (1651)	6'-5" (1956)	16'-10" (5131)	16'-11" (5156)
3500 (1588)	5'-5" (1651)	5'-5" (1651)	14'-10" (4521)	16'-11" (5156)	5'-5" (1651)	6'-5" (1956)	16'-4" (4978)	16'-11" (5156)	5'-5" (1651)	6'-5" (1956)	16'-4" (4978)	16'-11" (5156)
4000 (1814)	5'-6" (1676)	5'-6" (1676)	15'-1" (4597)	16'-11" (5156)	5'-6" (1676)	6'-6" (1981)	16'-7" (5055)	16'-11" (5156)	7'-5" (2261)	8'-5" (2565)	16'-11" (5156)	16'-11" (5156)

Visit kone.us for the latest project-specific details, BIM Models, CAD drawings, specifications, electrical data, reaction loads and building access requirements.

CONTROL SPACE ⁽¹⁰⁾		(J)	(K)	(L)
CAPACITY LBS. (kg)	CONTROLLER SPACE	WIDTH (mm)	DEPTH (mm)	DOOR WIDTH (mm)
2000 to 4000 (907 to 1814)	Integral or Remote Cabinet	4'-4" (1321)	1'-8" (508)	4'-0" (1219)
2000 to 4000 (907 to 1814)	Adjacent or Remote Room	5'-0" (1524)	Dimension (B)	3'-0" (914)

Notes

- (1) Smaller pit and overhead dimensions may be available per specific applications. Contact your KONE Sales Professional for further information.
- (2) Buffer service platforms are required when pit depth exceeds 8'-6" (2590 mm).
- (3) Hoist beams (by KONE) are required for installation (by others). Dimension (H) reflects clear under hoist beam.
- (4) If occupied space exists below the hoistway, consult your KONE Sales Professional.
- (5) All dimensions are based on an 8'-0" (2438 mm) cab with a 7'-0" (2134 mm) door. Alternate car and door heights are available, but may affect dimension (H).
- (6) Add 8" (203 mm) in non-seismic and 12" (305 mm) in seismic zones to clear overhead dimension (H) for front-only passenger car if cab features glass-back wall.
- (7) If an Emergency Battery Device (EBD) is required, please contact your KONE Sales Professional for further details regarding dimensions (J) and (L).
- (8) Contact your local KONE Sales Professional regarding local code variations when utilizing the integral and remote closet options.
- (9) If utilizing KONE destination control system or KONE Access™, contact your local KONE Sales Professional regarding control space size requirements.

Plan Views

Section View

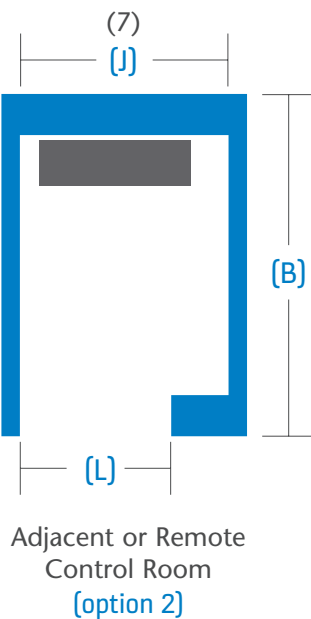
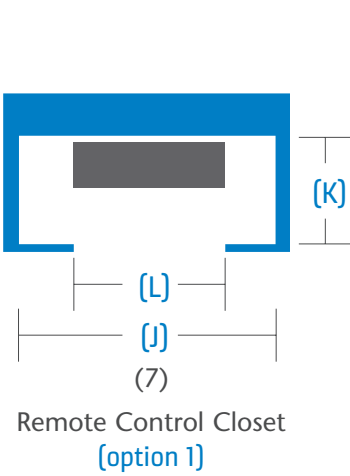
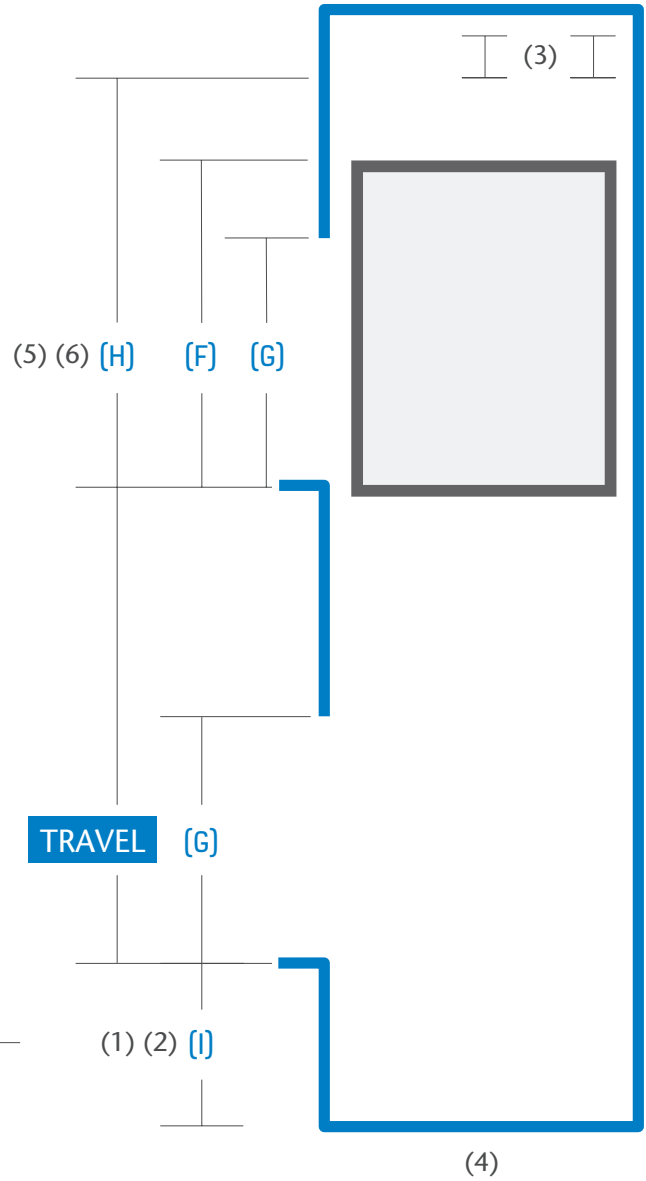
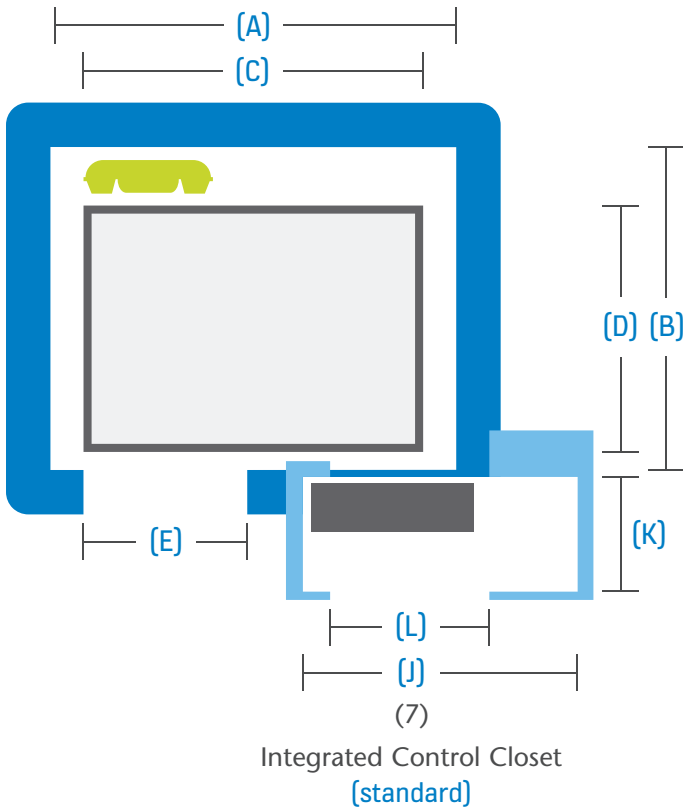

KONE MONOSPACE[®] 700 DX

MACHINE AT SIDE CONFIGURATION & DIMENSIONS

Max Travel 300 ft. (91.4 m)

Speed

200, 350, 500 fpm
(1.0, 1.78, 2.54 m/s)

Car Height (F)

8, 9 or 10 ft.
(2438, 2743 or 3048 mm)

Entrance Height (G)

7, 8 or 9 ft.
(2134, 2438 or 2743 mm)

Available in passenger and service shape with front and rear opening options.

			(A)	(A) SEISMIC	(B)	(B) SEISMIC	(C)	(D)	(E)	
		CAPACITY LBS. (kg)	OPENING TYPE [†]	HOISTWAY WIDTH (mm)	HOISTWAY WIDTH (mm)	HOISTWAY DEPTH (mm)	HOISTWAY DEPTH (mm)	INTERIOR WIDTH (mm)	INTERIOR DEPTH (mm)	DOOR WIDTH (mm)
FRONT OPENING	PASSENGER	2500 (1134)	SSP / CO	9'-5" (2870)	9'-9" (2972)	6'-10" (2083)	7'-3" (2210)	6'-8½" (2045)	4'-3¼" (1302)	3'-6" (1067)
		3000 (1361)	SSP / CO	9'-5" (2870)	9'-9" (2972)	7'-1" (2159)	7'-5" (2261)	6'-8½" (2045)	4'-9¼" (1454)	3'-6" (1067)
		3500 (1588)	SSP / CO	9'-5" (2870)	9'-9" (2972)	7'-5" (2261)	7'-8" (2337)	6'-8½" (2045)	5'-5¼" (1657)	3'-6" (1067)
		4000 (1814)	CO	10'-5" (3175)	10'-9" (3277)	7'-5" (2261)	7'-8" (2337)	7'-8½" (2350)	5'-5¼" (1657)	4'-0" (1219)
	SERVICE	4000 (1814)	2SP	8'-5" (2565)	8'-9" (2667)	9'-5" (2870)	9'-7" (2921)	5'-8½" (1740)	7'-6" (2286)	4'-0" (1219)
		5000 AIA (2268)	2SP	8'-5" (2565)	8'-9" (2667)	10'-7¾" (3245)	10'-10¾" (3296)	5'-8½" (1740)	9'-0" (2743)	4'-6" (1372) ⁽⁹⁾
FRONT & REVERSE OPENING	PASSENGER	2500 (1134)	SSP / CO	9'-5" (2870)	9'-9" (2972)	7'-1" (2159)	7'-1" (2159)	6'-8½" (2045)	4'-3¼" (1314)	3'-6" (1067)
		3000 (1361)	SSP / CO	9'-5" (2870)	9'-9" (2972)	7'-6" (2286)	7'-6" (2286)	6'-8½" (2045)	4'-9¼" (1467)	3'-6" (1067)
		3500 (1588)	SSP / CO	9'-5" (2870)	9'-9" (2972)	7'-9½" (2375)	7'-9½" (2375)	6'-8½" (2045)	5'-5¾" (1670)	3'-6" (1067)
		4000 (1814)	CO	10'-5" (3175)	10'-9" (3277)	7'-9½" (2375)	7'-9½" (2375)	7'-8½" (2350)	5'-5¾" (1670)	4'-0" (1219)
	SERVICE	4000 (1814)	2SP	8'-5" (2565)	8'-9" (2667)	10'-1" (3073)	10'-1" (3073)	5'-8½" (1740)	7'-6½" (2299)	4'-0" (1219)
		5000 AIA (2268)	2SP	8'-5" (2565)	8'-9" (2667)	11'-2¾" (3423)	11'-2¾" (3423)	5'-8½" (1740)	8'-8¼" (2648)	4'-6" (1372) ⁽⁹⁾

† SSP = Single Speed Side Opening / CO = Single Speed Center Opening / 2SP = Two Speed Side Opening

CLEAR OVERHEAD (H) AND PIT DEPTH (I)						
CAPACITY LBS. (kg)	200 FPM (1.00 M/S)		350 FPM (1.78 M/S)		500 FPM (2.54 M/S)	
	PIT DEPTH (mm)	CLEAR OVERHD (mm)	PIT DEPTH (mm)	CLEAR OVERHD (mm)	PIT DEPTH (mm)	CLEAR OVERHD (mm)
2500 (1134)	5'-3" (1600)	13'-7" (4140)	5'-5" (1651)	13'-11" (4242)	5'-5" (1651)	13'-11" (4242)
3000 (1361)	5'-5" (1651)	13'-7" (4140)	5'-5" (1651)	14'-4" (4369)	5'-5" (1651)	14'-4" (4369)
3500 (1588)	5'-5" (1651)	13'-7" (4140)	5'-5" (1651)	14'-9" (4496)	5'-5" (1651)	14'-9" (4496)
4000 (1814)	5'-8" (1727)	13'-7" (4140)	5'-8" (1727)	14'-11" (4547)	7'-3" (2210)	15'-8" (4775)
4500 (2041)	5'-8" (1727)	14'-9" (4496)	5'-11" (1803)	15'-3" (4648)	7'-6" (2286)	16'-0" (4877)
5000 – 5000 AIA (2268)	5'-11" (1803)	15'-2" (4623)	5'-11" (1803)	15'-11" (4851)	—	—

CAPACITY LBS. (kg)	CONTROL SPACE ⁽¹⁰⁾	(J)	(K)	(L)
	CONTROLLER SPACE	WIDTH (mm)	DEPTH (mm)	DOOR WIDTH (mm)
2500 to 5000 AIA (1134 to 2268)	Integral or Remote Cabinet	4'-4" (1321) ⁽¹⁰⁾	1'-8" (508) ⁽¹⁰⁾	4'-0" (1219) ⁽¹⁰⁾
2500 to 5000 AIA (1134 to 2268)	Adjacent or Remote Room	5'-0" (1524)	Dimension (B)	3'-0" (914) ⁽¹⁰⁾

Visit kone.us for the latest project-specific details, CAD drawings, BIM models, CSI specifications, electrical data, reaction loads and building access requirements.

Notes

- Smaller pit and overhead dimensions may be available per specific applications. Contact your KONE Sales Professional for further information.
- Buffer service platforms are required when pit depth exceeds 8'-6" (2590 mm).
- A hoist beam (by KONE) is required for installation (by others). Dimension (H) reflects clear under hoist beam.
- If occupied space exists below the hoistway, consult your KONE Sales Professional.
- All dimensions are based on an 8'-0" (2438 mm) cab with a 7'-0" (2134 mm) door. Alternate car and door heights are available, but will affect dimension (H).
- If an Emergency Battery Device (EBD) is required, please contact your KONE Sales Professional for further details regarding dimensions (J) and (L).
- Contact your local KONE Sales Professional regarding local code variations when utilizing the integral and remote closet options.
- If utilizing KONE destination control system or KONE Access™, contact your local KONE Sales Professional regarding control space size requirements.
- 4'-0" (1219 mm) door width also available.
- If IBC 2018 or ASME A17.1-2019/CSA B44-19 code is applicable, contact your local sales professional for controller space configurations.

Plan Views

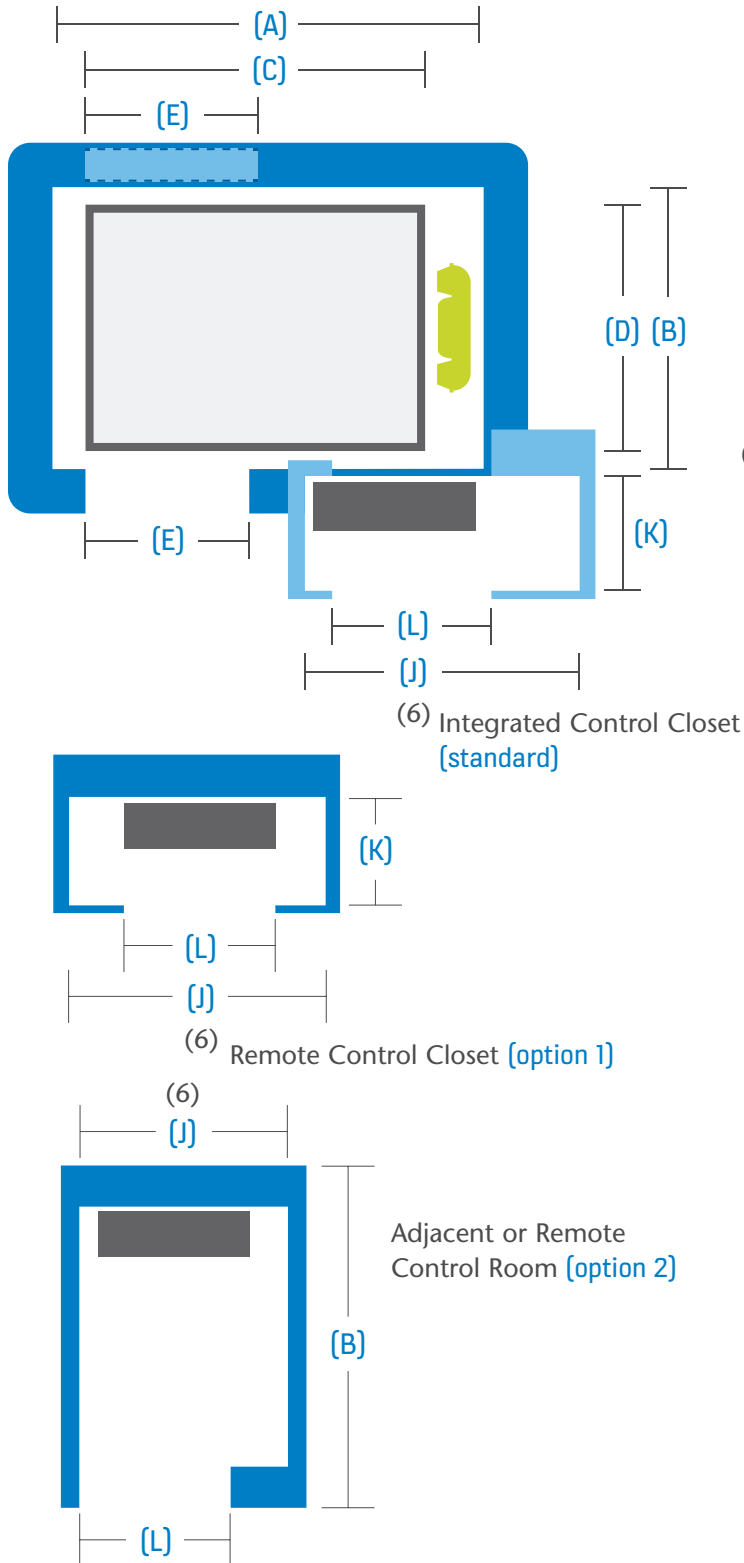

Section View

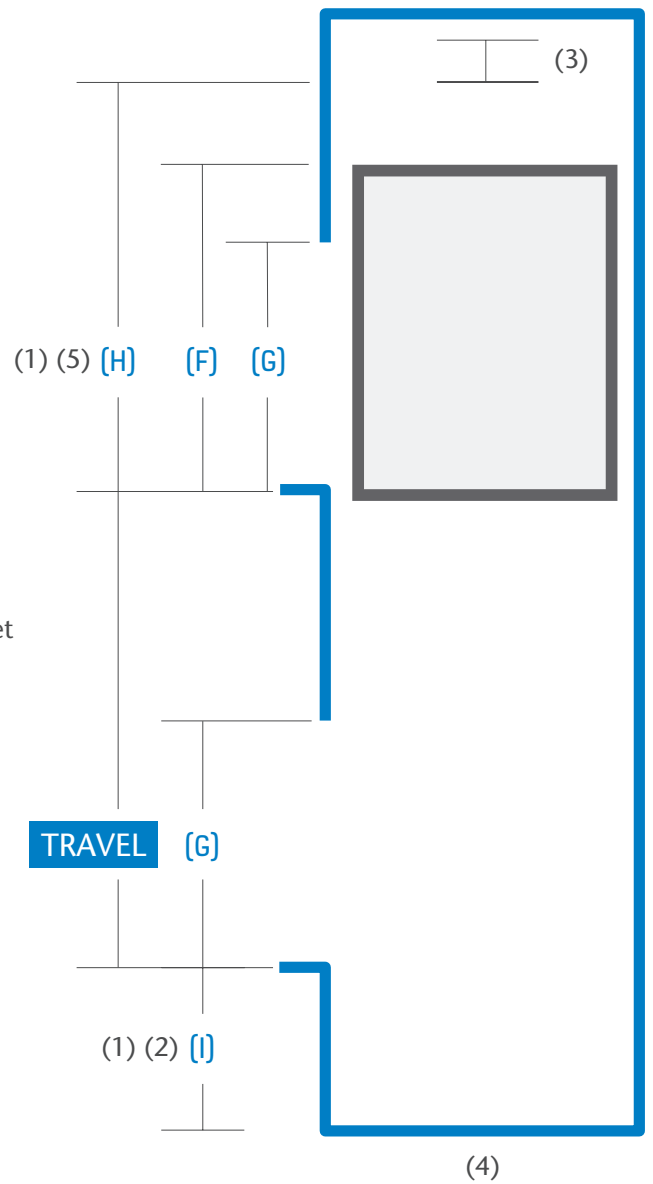

KONE MINISPACE™ DX

CONFIGURATIONS & DIMENSIONS

Max Travel 590 ft. (180 m)
Max Landings 63

Speed
200, 350, 400, 500, 700, 1000 fpm
(1.00, 1.78, 2.00, 2.54, 3.56, 5.00 m/s)

Car Height (F)
8, 9 or 10 ft.
(2438, 2743 or 3048 mm)

Entrance Height (G)
7, 8 or 9 ft.
(2134, 2438 or 2743 mm)

Clear Overhead (I)
and Pit Depth (J)

			(A)	(A) SEISMIC	(B)	(C)	(D)	(E)	
		CAPACITY LBS. (kg)	OPENING TYPE†	HOISTWAY WIDTH (mm)	HOISTWAY WIDTH (mm)	HOISTWAY DEPTH (mm)	INTERIOR WIDTH (mm)	INTERIOR DEPTH (mm)	DOOR WIDTH (mm)
FRONT OPENING	PASSENGER	2000 (907)	SSP	7'-4" (2235)	7'-8" (2337)	6'-10" (2083)	5'-8½" (1740)	4'-3¼" (1302)	3'-0" (914)
		2500 (1134)	SSP / CO	8'-4" (2540)	8'-8" (2642)	6'-8" (2032)	6'-8½" (2045)	4'-3¼" (1302)	3'-6" (1067)
		3000 (1361)	SSP / CO	8'-4" (2540)	8'-8" (2642)	7'-2" (2184)	6'-8½" (2045)	4'-9¼" (1454)	3'-6" (1067)
		3500 (1588)	SSP / CO	8'-4" (2540)	8'-8" (2642)	7'-10" (2388)	6'-8½" (2045)	5'-5¼" (1657)	3'-6" (1067)
		4000 (1814)	CO	9'-4" (2845)	9'-8" (2946)	7'-10" (2388)	7'-8½" (2350)	5'-5¼" (1657)	4'-0" (1219)
	SERVICE	4000 (1814)	2SP	8'-1" (2464)	8'-4" (2540)	9'-2" (2794)	5'-8½" (1740)	7'-6" (2286)	4'-0" (1219)
		4500 (2041)	2SP	8'-1" (2464)	8'-4" (2540)	9'-8" (2946)	5'-8½" (1740)	8'-0" (2438)	4'-0" (1219)
		5000 (2268)	2SP	8'-1" (2464)	8'-4" (2540)	10'-2" (3099)	5'-8½" (1740)	8'-7¾" (2635)	4'-6" (1372) ⁽⁹⁾
		5000 AIA (2268)	2SP	8'-8" (2642)	8'-11" (2718)	10'-7¾" (3245)	5'-8½" (1740)	9'-0" (2743)	4'-6" (1372) ⁽⁹⁾
		FRONT & REVERSE OPENING	PASSENGER	2000 (907)	SSP	8'-4" (2540)	8'-8" (2642)	6'-3¼" (1911)	5'-8½" (1740)
2500 (1134)	SSP / CO			9'-4" (2845)	9'-8" (2946)	6'-3¼" (1911)	6'-8½" (2045)	4'-3¾" (1314)	3'-6" (1067)
3000 (1361)	SSP / CO			9'-4" (2845)	9'-8" (2946)	6'-9¼" (2064)	6'-8½" (2045)	4'-9¾" (1467)	3'-6" (1067)
3500 (1588)	SSP / CO			9'-4" (2845)	9'-8" (2946)	7'-5¼" (2267)	6'-8½" (2045)	5'-5¾" (1670)	3'-6" (1067)
4000 (1814)	CO			10'-4" (3150)	10'-8" (3251)	7'-5¼" (2267)	7'-8½" (2350)	5'-5¾" (1670)	4'-0" (1219)
SERVICE	4000 (1814)		2SP	8'-1" (2464)	8'-4" (2540)	10'-1" (3073)	5'-8½" (1740)	7'-6½" (2299)	4'-0" (1219)
	4500 (2041)		2SP	8'-1" (2464)	8'-4" (2540)	10'-7" (3226)	5'-8½" (1740)	8'-0½" (2451)	4'-0" (1219)
	5000 (2268)		2SP	8'-1" (2464)	8'-4" (2540)	11'-2¾" (3423)	5'-8½" (1740)	8'-8¼" (2648)	4'-6" (1372) ⁽⁹⁾
	5000 AIA (2268)		2SP	8'-8" (2642)	9'-0" (2743)	11'-6¾" (3524)	5'-8½" (1740)	9'-0" (2743)	4'-6" (1372) ⁽⁹⁾

† SSP = Single Speed Side Opening / CO = Single Speed Center Opening / 2SP = Two Speed Side Opening

CLEAR OVERHEAD (I) AND PIT DEPTH (J)										
CAPACITY LBS. (kg)	200 FPM (1.00 M/S)		350 FPM (1.78 M/S)		400 FPM (2.03 M/S)		500 FPM (2.54 M/S)		700 FPM (1,2,3) 3.56 m/s (1,2,3)	
	PIT DEPTH (mm)	CLEAR OVERHD (mm)	PIT DEPTH (mm)	CLEAR OVERHD (mm)	PIT DEPTH (mm)	CLEAR OVERHD (mm)	PIT DEPTH (mm)	CLEAR OVERHD (mm)	PIT DEPTH (mm)	CLEAR OVERHD (mm)
2000 (907)	—	—	—	—	—	—	—	—	10'-6" (3200)	21'-0" (6401)
2500-3500 (1134-1588)	5'-3" (1600)	14'-1" (4292)	5'-6" (1676)	14'-7" (4445)	6'-0" (1829)	14'-11" (4547)	6'-10" (2083)	15'-8" (4775)	10'-6" (3200)	21'-0" (6401)
4000 (1814)	5'-3" (1600)	14'-1" (4292)	5'-6" (1676)	14'-7" (4445)	6'-0" (1829)	14'-11" (4547)	6'-10" (2083)	15'-8" (4775)	—	—
4500 (2041)	5'-3" (1600)	14'-7" (4445)	5'-6" (1676)	15'-1" (4597)	6'-0" (1829)	15'-5" (4953)	6'-10" (2083)	16'-2" (4928)	—	—
5000 (2268)	5'-3" (1600)	14'-7" (4445)	5'-6" (1676)	15'-1" (4597)	6'-0" (1829)	15'-5" (4953)	6'-10" (2083)	16'-2" (4928)	—	—
5000 AIA (2268)	5'-6" (1676)	14'-9" (4496)	5'-8" (1727)	15'-1" (4597)	7'-2" (2184)	16'-2" (4928)	7'-2" (2184)	16'-2" (4928)	—	—

Visit kone.us for the latest project-specific details, BIM models, CAD drawings, specifications, electrical data, reaction loads and building access requirements.

Notes

- For speeds above 1000 fpm (5.00 m/s) or travel above 590' (180 m) contact your KONE Sales Professional for design and planning assistance.
- For 700 fpm (3.56 m/s) and 1000 fpm (5.00 m/s) front opening passenger configurations add 2" (51 mm) to the hoistway depth (B).
- Information is based upon chain compensation. For rope compensation applications, please consult your KONE Sales Professional.
- All dimensions are based on an 8'-0" (2,438 mm) cab with a 7'-0" (2,134 mm) door. Alternate car and door heights are available, but will affect dimension (I).
- If occupied space exists below the hoistway, consult your KONE Sales Professional.
- Information is based upon structural machine room floor slabs. For machine beam applications, please consult your KONE Sales Professional.
- Machine room height of 8'-0" (2,438 mm) is measured from the machine room floor surface to underside of the lowest obstruction above the machine (H). Consult your KONE Sales Professional for details.
- For service applications the machine room is not centered on the hoistway and requires an additional 7" (178 mm) of width. The additional 7" (178 mm) should be added to the counterweight side. Consult your KONE Sales Professional for details.
- 4'-0" (1219 mm) door width also available.

Section view

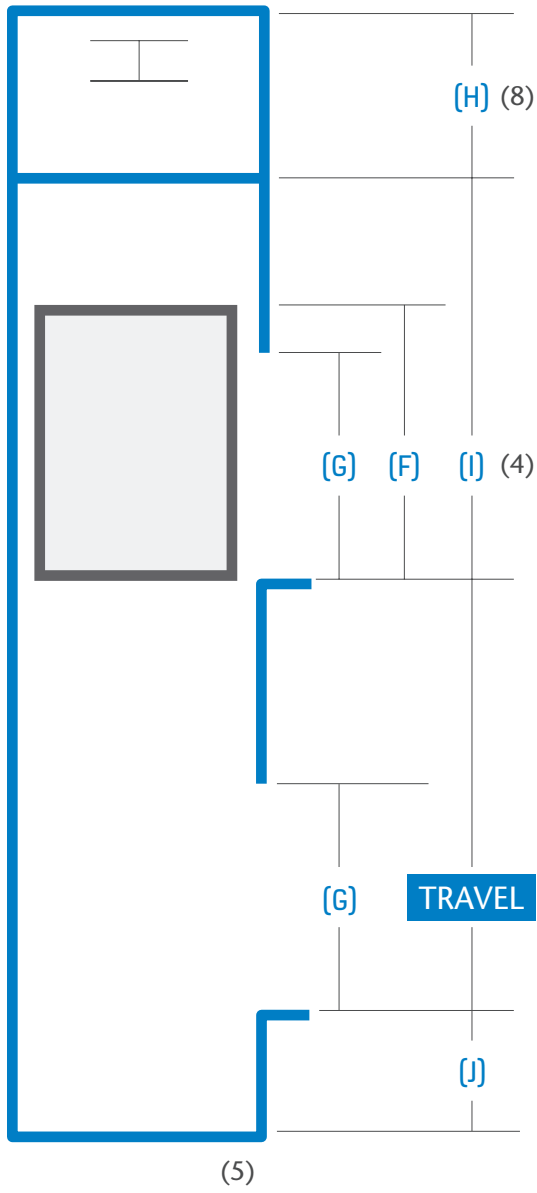

Plan views

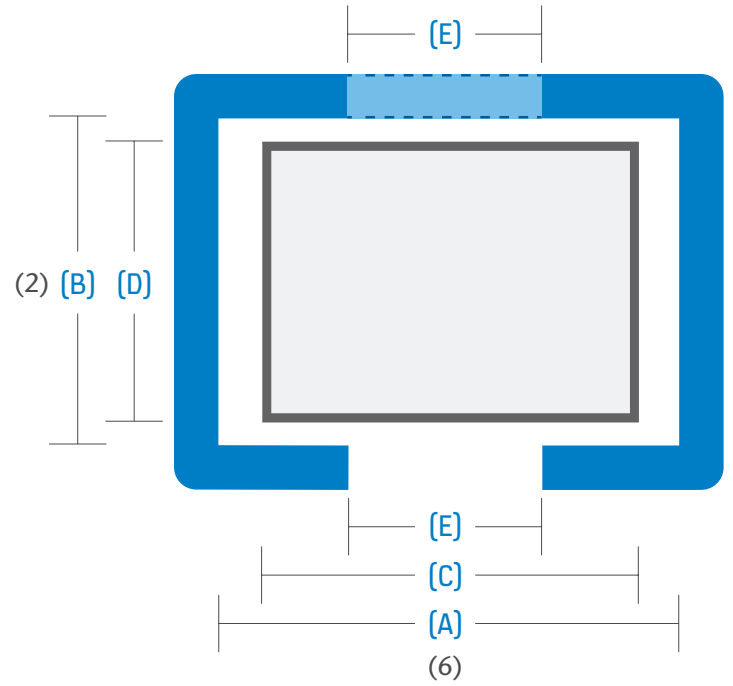

Machine Room

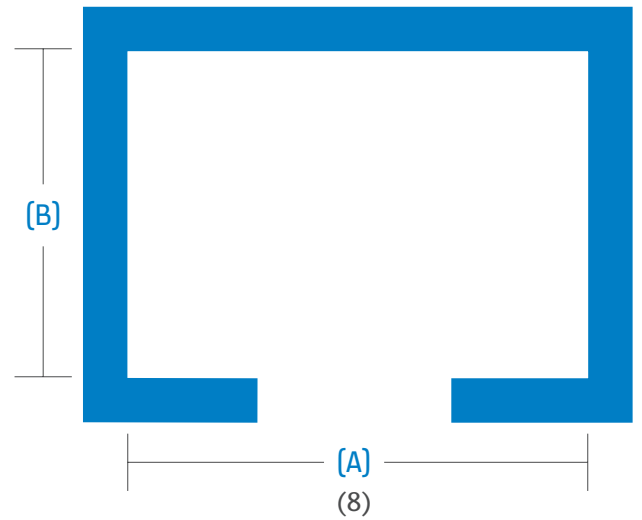

AN INTRODUCTION TO ESCALATORS AND AUTOWALKS

Definitions and components

An escalator is a moving staircase for transporting people between floors of a building. It is generally agreed that an escalator is the most efficient means to move large numbers of people between floors.

Item	Component	Item	Component
1	Handrail	11	Transition radii
2	Skirting	12	Truss
3	Steps/pallets	13	Side cladding
4	Decking	14	Step chain
5	Balustrade	15	Tracks
6	Horizontal steps/pallets	16	Return station
7	Drive station	17	Access cover plate
8	Controller	18	Newel
9	Front plate		
10	Handrail drive		

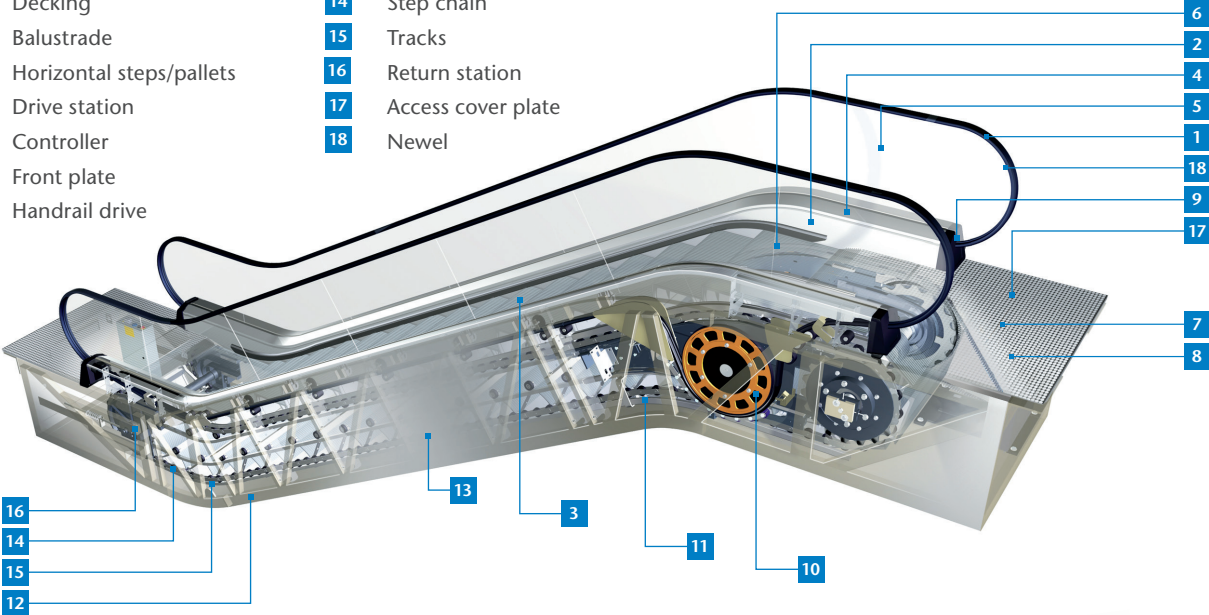

A horizontal autowalk is a conveyor belt that transports people horizontally. Autowalks are generally provided in areas where people need to walk long distances with luggage, baggage carts or shopping carts. An autowalk is generally flat, but can be slightly inclined.

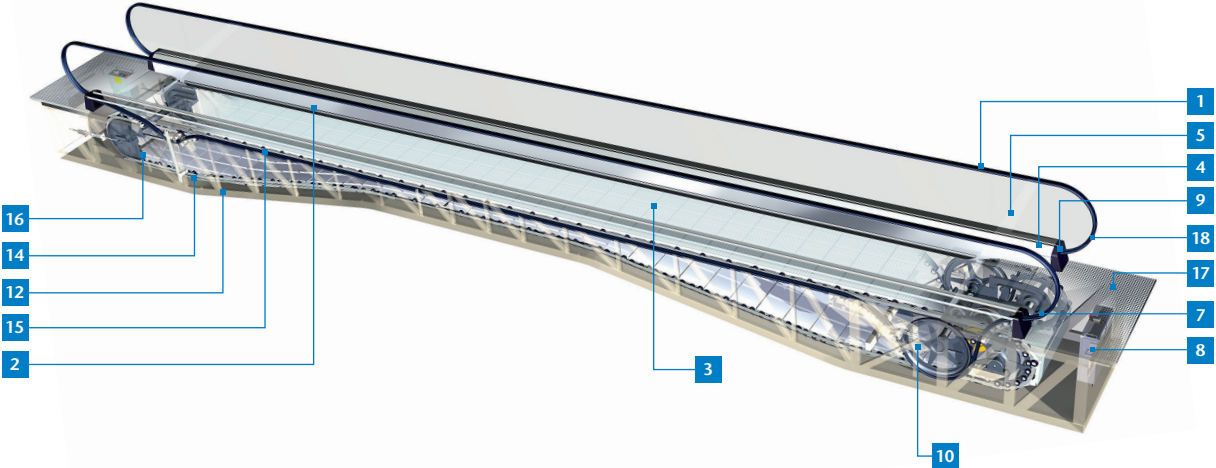

KONE ESCALATORS AND AUTOWALKS

- Quiet, smooth operation
- Small installation dimensions
- Eco-efficient and economical
- High levels of reliability
- Design options to match the image of your building

KONE TransitMaster™ 210

Application	Supermarkets, department stores, shopping centers
Type	Escalator
Rise	Up to 52' 5" (16 m)
Nominal Step Width	24", 32", 40" (600, 800, 1000 mm)
Balustrade	Glass or solid
Speed	100 fpm (.50 m/s)

The KONE TransitMaster 210 is a commercial escalator targeted primarily toward the retail segment – supermarkets, department stores and shopping centers. It is designed, from both a technical and visual point of view, to fulfill customer requirements in various target segments.

KONE TransitMaster™ 220

Application	Stadiums, Arenas, Convention Centers, Airports, Light Rail
Type	Escalator
Rise	Up to 49' 2" (15 m)
Nominal Step Width	24", 32", 40" (600, 800, 1000 mm)
Balustrade	Glass or Solid
Speed	100 fpm (0.5 m/s)

The KONE TransitMaster 220 is a heavy-duty escalator targeted primarily towards the Infrastructure segment, and in particular mid to high duty applications. This segment covers airports, rail and transportation systems as well as other transit centers. Airports and rail systems are the most common target buildings for this solution.

KONE TransitMaster™ 180

Application	Heavy traffic, public transportation, metro
Type	Escalator
Nominal Step Width	24", 32", 40" (600, 800, 1000 mm)
Balustrade	Glass or solid
Speed	100 fpm (.50 m/s)

The versatile KONE TransitMaster 180 escalator is ideal for new installations and is specifically designed to meet the demanding needs of public transportation all the way up to the demanding requirements of mass transit airport and railway systems. Our heavy-duty escalators are designed to enable the seamless flow of large numbers of passengers.

KONE TransitMaster™ 165/185

Application	Heavy traffic, airports, public transportation, metro
Type	Autowalk
Length	Per requirements
Nominal Pallet Width	32", 40", 48", 56" (800, 1000, 1200, 1400 mm)
Balustrade	Glass or solid
Speed	100 or 130 fpm (.50 or .66 m/s)

The KONE Autowalk achieves the perfect balance between form and function. An attractive welcome area invites passengers to take an uncommonly smooth and quiet ride, while offering options to meet your architectural vision.

KONE EcoMod®

Application	Retail, airports, stadiums, hotels, leisure venues
Type	Complete escalator modernization
Nominal Step Width	24", 32", 40" (600, 800, 1000 mm)
Balustrade	Glass or solid
Speed	100 fpm (.50 m/s)

The KONE EcoMod escalator modernization solution offers an innovative and systematic approach to replacing the entire workings of your escalators and delivering brand new technology without expensive, disruptive truss removal.

KONE TRANSITMASTER™ 210

Commercial Escalator Product

With over 100 years of experience in the elevator and escalator industry, KONE is your trusted partner, dedicated to ensuring smooth People Flow™. KONE's reliable escalator solutions use proven technology and is designed to meet the needs of demanding commercial environments, such as supermarkets, department stores and shopping centers. It is also suitable for hotels, offices, hospitals, leisure facilities and airports.



The main benefits of the TransitMaster 210

- Attractive design helps to create a pleasant ambiance in the building
- All visual options can be customized to fit the customers overall building design
- Harmonized look and feel across the product portfolio
- LED lighting solutions support increase passenger safety
- Serves the customers building throughout its entire lifecycle
- Smart Technology: KONE 24/7 Connected Services.

Main Characteristics of the TransitMaster 210

Market Segment	Retail, Office, Medical, Small Airports
Maximum rise	up to 52' 2" (16 m)
Inclination	30°
Transition radii	Lower Radius: 1.0 or 2.0 (m) Upper Radius: 1.0, 1.5, 2.7 (m)
Speed	100 fpm (0.5 m/s)
Step width	24", 32", 40" (600, 800, 1000 mm)
Step load	192 lbs. / step
Horizontal steps	2/2 or 3/3
Handrail Type	C-Type
Balustrade type	Glass, Solid stainless steel inclined
Balustrade glass thickness	3/8" (10mm) and 1/2" (12mm)
Balustrade height	40" (1000 mm)
Skirt material	Black teflon
Front plate material	Black plastic
Environment	Indoor / Outdoor
Load profile	Overall load profile 42% 12h/day; 7 days/week: 2% time at 100% load 35% time at 50% load 63% time at 25% load

Configuration & Dimensions

KONE TRANSITMASTER 210 BASIC DATA											
Inclination	Level Steps	Radii	Maximum Vertical Rise	Nominal Step Width	Balustrade	Balustrade height	Speed	Electrification	Chain Type	Handrail	Environment
30 degrees	2 or 3 Level Steps	Lower Radius: 1.0 or 2.0 (meters) Upper Radius: 1.0, 1.5, 2.7 (meters)	52' 5" (16 m)	24", 32" and 40" (600,800, 1000 mm)	Glass and solid incline	3'-3' 3/8" (1000 mm)	100 FPM (0.5 m/s)	NFPA 70 and CSA-C22.1	Inside Chain Roller	C-Type	Indoor/ Outdoor

DIMENSION BB/EE (UPPER HEAD) FOR NON-SEISMIC						
W1: Step Width	H: Rise	BB				EE
		Level steps - up radius / low radius (m)				
		2-1.0/1.0	2-1.5/1.0	3-1.5/1.0	3-2.7/2.0	
40" (1000 mm)	8' 2 7/8" - 15' 9" (2500 mm - 4800 mm)	8' 3/8" (2455 mm)	8' 5 1/8" (2589 mm)	9' 8 1/8" (2949 mm)	10' 4 1/8" (3173 mm)	1' 9 1/8" (535 mm)
	15' 9" - 31' 9 7/8" (4801 mm - 9700 mm)	8' 3 7/8" (2525 mm)	8' 8 1/8" (2659 mm)	9' 10 7/8" (3019 mm)	10' 4 1/8" (3243 mm)	1' 11 1/8" (605 mm)
	31' 9 1/8" - 52' 5 1/8" (9701 mm - 16000 mm)	9' 8 7/8" (2955 mm)	10' 1 1/8" (3089 mm)	11' 3 1/8" (3449 mm)	12' 5/8" (3673 mm)	3' 4 3/4" (1035 mm)
32" (800 mm)	8' 2 7/8" - 34' 5 3/8" (2500 mm - 10500 mm)	8' 7 3/8" (2625 mm)	9' 3/8" (2759 mm)	10' 2 1/8" (3119 mm)	10' 11 1/8" (3343 mm)	2' 3 3/4" (705 mm)
24" (600 mm)	8' 2 7/8" - 39' 4 7/8" (2500 mm - 12000 mm)	9' 8 7/8" (2955 mm)	10' 1 1/8" (3089 mm)	11' 3 1/8" (3449 mm)	12' 5/8" (3673 mm)	3' 4 3/4" (1035 mm)

DIMENSION AA/DD (LOWER HEAD) FOR NON-SEISMIC						
W1: Step Width	Truss/comb heating	AA				DD
		Level steps - up radius / low radius (m)				
		2-1.0/1.0	2-1.5/1.0	3-1.5/1.0	3-2.7/2.0	
40" (1000 mm)	Without/With	7' 3 3/8" (2226 mm)	7' 3 3/8" (2226 mm)	8' 3 3/8" (2534 mm)	9' 1 3/8" (2777 mm)	1' 9 1/8" (535 mm)
32"/24" (800 mm / 600 mm)	Without	7' 3 3/8" (2226 mm)	7' 3 3/8" (2226 mm)	8' 3 3/8" (2534 mm)	9' 1 3/8" (2777 mm)	1' 9 1/8" (535 mm)
32"/24" (800 mm / 600 mm)	With	8' 5 5/8" (2576 mm)	8' 5 5/8" (2576 mm)	9' 5 5/8" (2884 mm)	10' 3 3/8" (3127 mm)	2' 10 1/8" (885 mm)

HA	HB	CC	FF	HL	HU
3' 3" (990 mm)	3' 1" (940 mm)	1.73205 x H	AA+7' 1/2" (AA+2139 mm)	3' 8 1/2" (1130 mm)	3' 8 1/2" (1130 mm)

Configuration & Dimensions

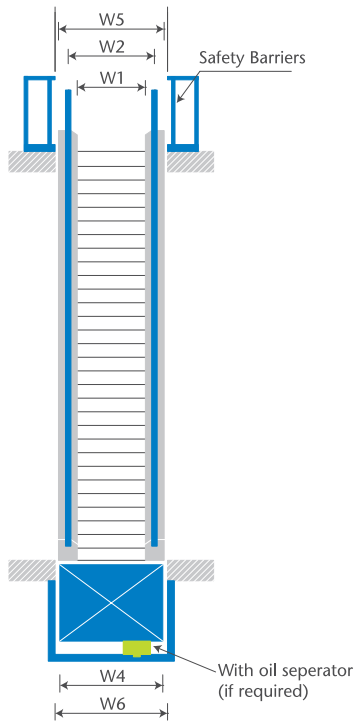
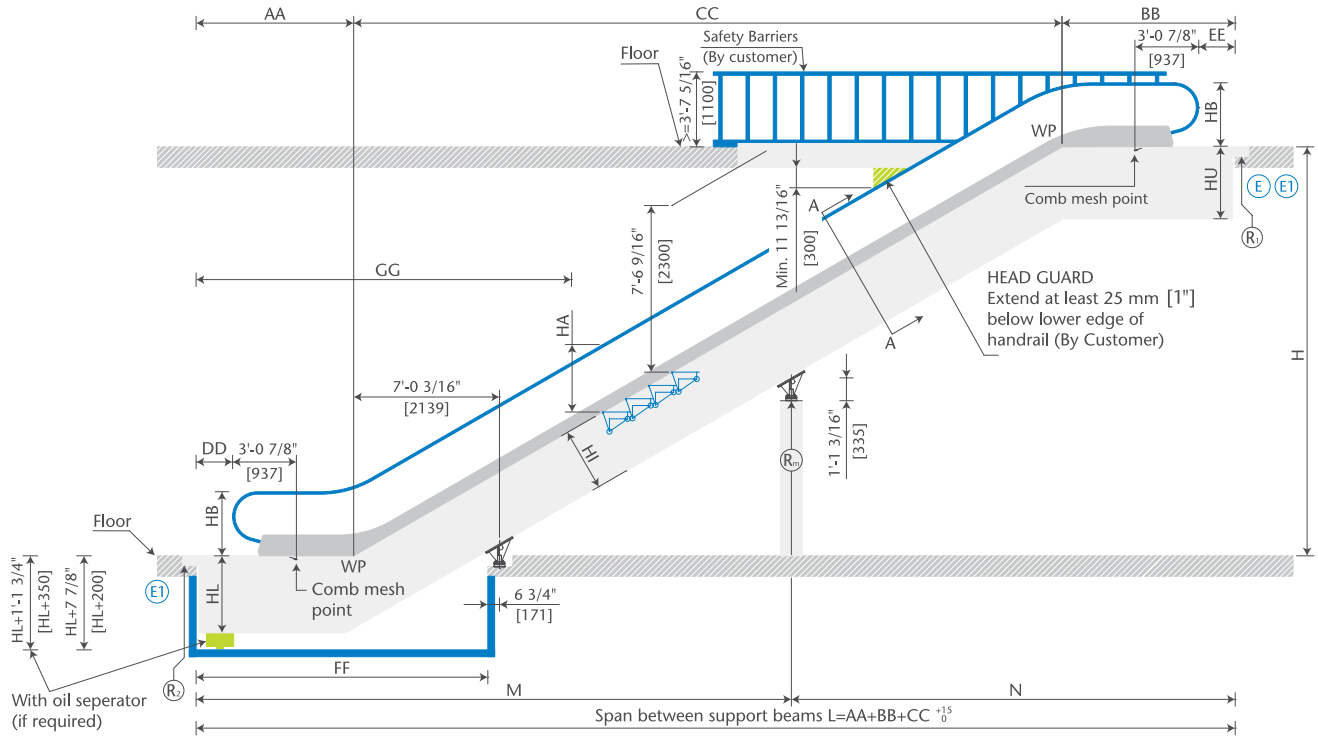

KEY WIDTH DIMENSIONS			
W1: Step width	3'-3 1/2" (1000 mm)	2' - 7 1/2" (800 mm)	1'-11 1/2" (600 mm)
W2: Handrail centerline distance	4'-1 11/16" (1262 mm)	3'-5 5/8" (1064 mm)	2'-10 1/8" (866 mm)
W4: Width of truss	4'-11 1/8" (1510 mm)	4' - 3 3/8" (1312 mm)	3' - 7 7/8" (1114 mm)
W5: Width of finished escalator	5'- 3 1/8" (1602 mm)	4' - 7 1/4" (1404 mm)	3'-11 1/2" (1206 mm)
W6: Width of pit	5'- 5 1/8" (1650 mm)	4' - 9 3/8" (1450 mm)	4' - 1 3/8" (1250 mm)

EXTENSION BY SEISMIC TYPE	
Seismic end support type	Increase for AA&BB&DD&EE
Type A	0' 1 3/4" (45 mm)
Type B	0' 1 3/4" (45 mm)
Type C	0' 3 1/8" (79 mm)
Type D	0' 4 1/8" (103 mm)
Type E	0' 5 5/8" (146 mm)
Type F	0' 8 1/8" (205 mm)
Type G	0' 10 3/8" (262 mm)
Type H	1' 3/8" (313 mm)

Notes

(1) Details represent standard KONE escalator configurations. Please consult your sales professional to review all possible deviations.

Visit KONE.us for the latest project-specific details, electrical data, reaction loads, planner tools and building access requirements.

*All drawings are for illustration purposes only.

KONE TRANSITMASTER™ 220

Public Transportation Escalator Product

With over 100 years of experience in the elevator and escalator industry, KONE is your trusted partner, dedicated to ensuring smooth People Flow™. KONE's reliable escalator solutions use proven technology and is designed to meet the needs of demanding public transportation environments, such as airports, rail and transportation systems as well as other transit centers.



The main benefits of the TransitMaster 220

- Extensive and flexible offering to match any need and environment
- Unconditional safety and reliability even under heavy People Flow
- Optimized total cost of ownership to meet the needs of the customer
- Optional features to offer environmentally friendly operation
- Elegant and modern design with numerous lighting options
- Smart Technology: KONE 24/7 Connected Services.

Main Characteristics of the TransitMaster 220

Market Segment	Stadiums, Arenas, Convention Centers, Airports, Light Rail
Maximum rise	up to 49' 2" (15 m)
Inclination	30°
Transition radii	Lower Radius: 1.5/1.0 (m) Upper Radius: 2.7/2.0 (m)
Speed	100 fpm (0.5 m/s)
Step width	24", 32", 40" (600, 800, 1000 mm)
Step load	264 lbs. / step
Step chain	Inside roller (75 mm x 23.5 mm)
Horizontal steps	2/2 or 3/3
Handrail Type	V-Type
Balustrade type	Glass, Solid inclined balustrade
Balustrade glass thickness	3/8" (10 mm) and 1/2" (12 mm)
Balustrade height	40" (1000 mm)
Skirt material	Stainless Steel
Front plate material	Stainless Steel
Environment	Indoor / Outdoor
Load profile	Overall load profile 54% 20h/day; 7 days/week 10% time at 100% load 40% time at 50% load 50% time at 25% load

Configuration & Dimensions

KONE TRANSITMASTER 210 BASIC DATA											
Inclination	Level Steps	Radii	Maximum Vertical Rise	Nominal Step Width	Balustrade	Balustrade height	Speed	Electrification	Chain Type	Handrail	Environment
30 degrees	2 or 3 Level Steps	Lower Radius: 1.5/1.0 (meters) Upper Radius: 2.7/2.0 (meters)	49' 2" (15 m)	24", 32" and 40" (600,800, 1000 mm)	Glass and solid incline	3'-3' 3/8" (1000 mm)	100 FPM (0.5 m/s)	NFPA 70 and CSA-C22.1	Inside Chain Roller	V-Type	Indoor/ Outdoor

DIMENSION BB/EE (UPPER HEAD) FOR NON-SEISMIC						
W1: Step Width	H: Rise	BB				EE
		Level steps - up radius / low radius (m)				
		2-1.0/1.0	2-1.5/1.0	3-1.5/1.0	3-2.7/2.0	
40" (1000 mm)	8' 2 7/8" - 11' 9 3/4" (2500 mm - 3600 mm)	8' 3/8" (2455 mm)	8' 5 1/8" (2589 mm)	9' 8 1/8" (2949 mm)	10' 4 1/8" (3173 mm)	1' 9 1/8" (535 mm)
	11' 9 3/4" - 23' 11 3/8" (3601 mm - 7300 mm)	8' 3 3/8" (2525 mm)	8' 8 1/8" (2659 mm)	9' 10 3/8" (3019 mm)	10' 7 1/8" (3243 mm)	1' 11 1/8" (605 mm)
	23' 11 3/8" - 52' 5 1/8" (7301 mm - 16000 mm)	9' 8 3/8" (2955 mm)	10' 1 1/8" (3089 mm)	11' 3 1/8" (3449 mm)	12' 3/8" (3673 mm)	3' 4 3/8" (1035 mm)
32" (800 mm)	8' 2 7/8" - 27' 10 3/8" (2500 mm - 8500 mm)	8' 7 3/8" (2625 mm)	9' 3/8" (2759 mm)	10' 2 3/8" (3119 mm)	10' 11 3/8" (3343 mm)	2' 3 3/8" (705 mm)
24" (600 mm)	8' 2 7/8" - 34' 5 3/8" (2500 mm - 10500 mm)	9' 8 3/8" (2955 mm)	10' 1 1/8" (3089 mm)	11' 3 1/8" (3449 mm)	12' 3/8" (3673 mm)	3' 4 3/8" (1035 mm)

DIMENSION AA/DD (LOWER HEAD) FOR NON-SEISMIC						
W1: Step Width	Truss/comb heating	AA				DD
		Level steps - up radius / low radius (m)				
		2-1.0/1.0	2-1.5/1.0	3-1.5/1.0	3-2.7/2.0	
40" (1000 mm)	Without/With	7' 3 3/8" (2226 mm)	7' 3 3/8" (2226 mm)	8' 3 3/8" (2534 mm)	9' 1 3/8" (2777 mm)	1' 9 1/8" (535 mm)
32"/24" (800 mm / 600 mm)	Without	7' 3 3/8" (2226 mm)	7' 3 3/8" (2226 mm)	8' 3 3/8" (2534 mm)	9' 1 3/8" (2777 mm)	1' 9 1/8" (535 mm)
32"/24" (800 mm / 600 mm)	With	8' 5 3/8" (2576 mm)	8' 5 3/8" (2576 mm)	9' 5 3/8" (2884 mm)	10' 3 3/8" (3127 mm)	2' 10 1/8" (885 mm)

HA	HB	CC	FF	HL	HU
3' 3" (990 mm)	3' 1" (940 mm)	1.73205 x H	AA+7' 1/2" (AA+2139 mm)	3' 8 1/2" (1130 mm)	3' 8 1/2" (1130 mm)

Configuration & Dimensions

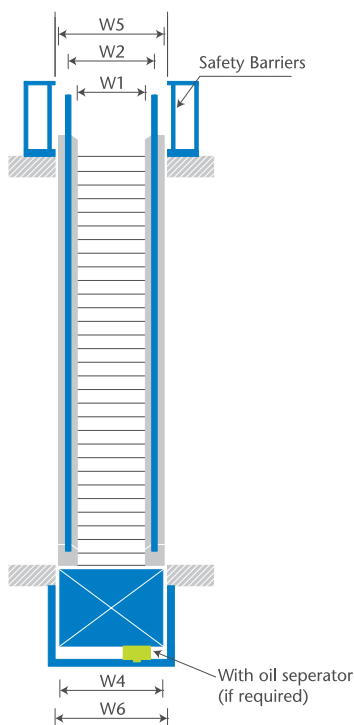
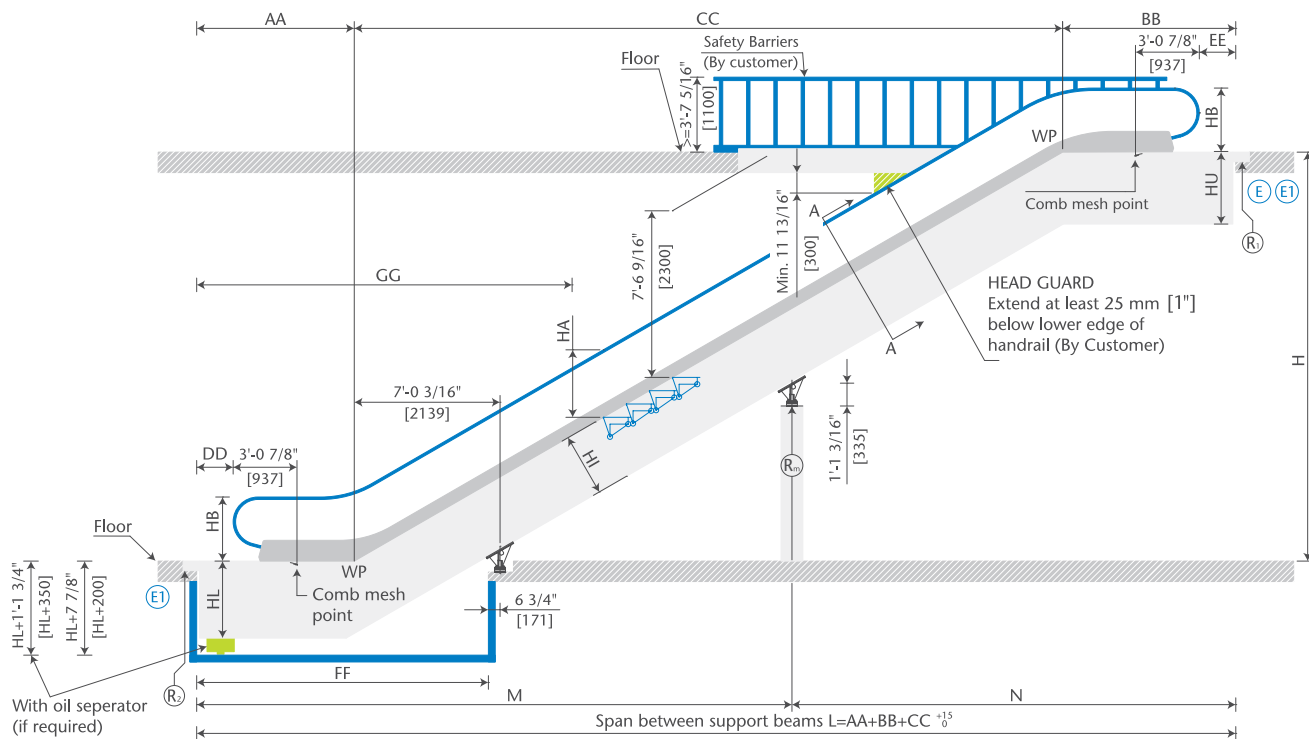

KEY WIDTH DIMENSIONS			
W1: Step width	3'-3 1/2" (1000 mm)	2' - 7 1/2" (800 mm)	1'-11 1/2" (600 mm)
W2: Handrail centerline distance	4'-1 11/16" (1262 mm)	3'-5 5/8" (1064 mm)	2'-10 1/8" (866 mm)
W4: Width of truss	4'-11 1/8" (1510 mm)	4' - 3 3/8" (1312 mm)	3' - 7 7/8" (1114 mm)
W5: Width of finished escalator	5'- 3 1/8" (1602 mm)	4' - 7 1/4" (1404 mm)	3'-11 1/2" (1206 mm)
W6: Width of pit	5'- 5 1/8" (1650 mm)	4' - 9 3/8" (1450 mm)	4' - 1 3/8" (1250 mm)

EXTENSION BY SEISMIC TYPE	
Seismic end support type	Increase for AA&BB&DD&EE
Type A	0' 1 3/4" (45 mm)
Type B	0' 1 3/4" (45 mm)
Type C	0' 3 1/8" (79 mm)
Type D	0' 4 1/8" (103 mm)
Type E	0' 5 5/8" (146 mm)
Type F	0' 8 1/8" (205 mm)
Type G	0' 10 3/8" (262 mm)
Type H	1' 3/8" (313 mm)

Notes

(1) Details represent standard KONE escalator configurations. Please consult your sales professional to review all possible deviations.

Visit KONE.us for the latest project-specific details, electrical data, reaction loads, planner tools and building access requirements.

*All drawings are for illustration purposes only.

KONE TRANSITMASTER™ 180

KONE TransitMaster 180 escalators are available in two step widths, glass or solid balustrades and many other available options and finishes. The robust design, coupled with excellence in manufacturing and service help make KONE TransitMaster 180 a great solution for public transportation applications such as railway or metro stations.

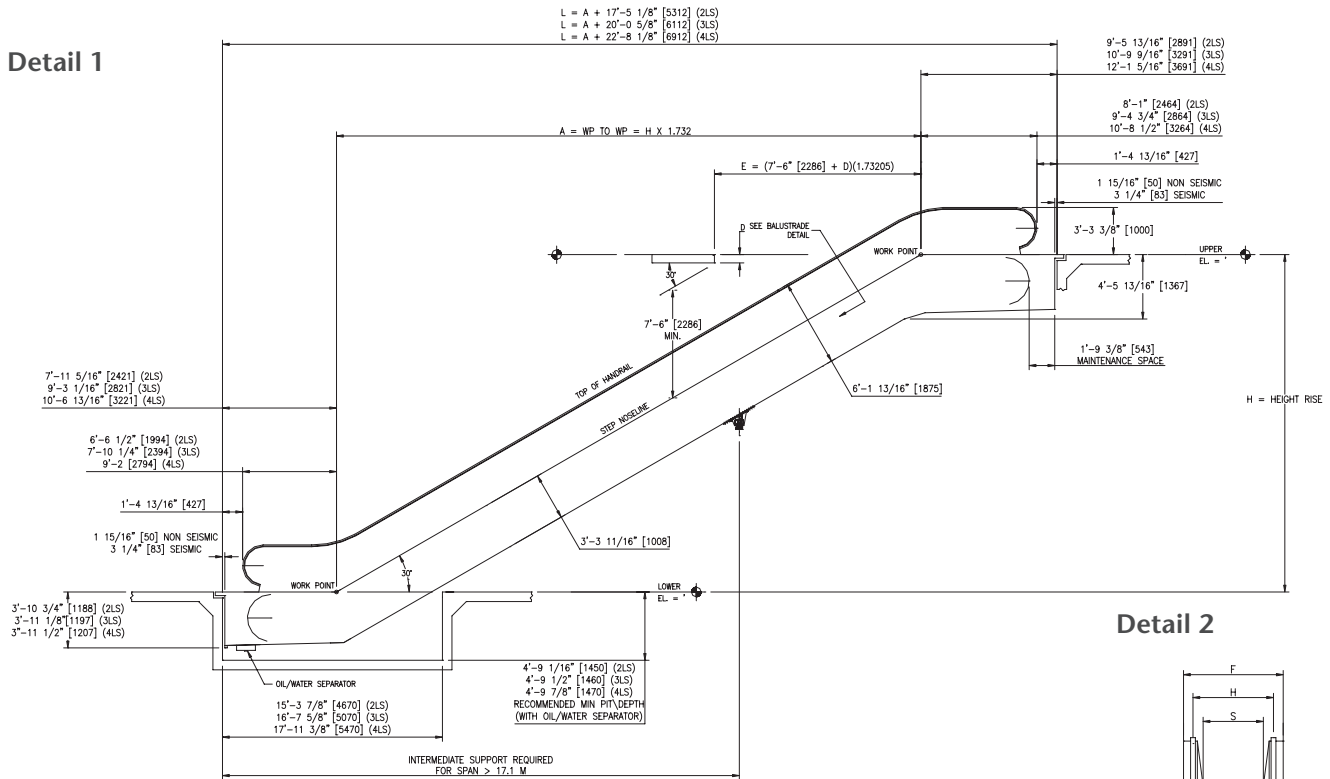

KONE TransitMaster 180 – Basic data	
Inclination	30 degrees
Level Steps	2-4 Level Steps
Radii	4'-11" or 8'-10" (1.5 or 2.7 m) Upper Radius
Maximum Vertical Rise	60'-0" (18 m)
Step Width	24", 32", 40" (600, 800, 1000 mm)
Balustrade	Glass or Solid Inclined
Balustrade Height	3'-3 3/8" (1000 mm)
Speed	100 fpm (0.5 m/s)
Electrification	NFPA 70 and CSA-C22.1
Chain Type	Outside Chain Roller
Handrail	V-type
Environment	Indoor / Outdoor

[...] DIMENSION IN MM

TYPE	600	800	1000
STEP WIDTH (NOMINAL) S	24" [600]	32" [800]	40" [1000]
TRUSS WIDTH T	3'-11 3/8" [1204]	4'-7 3/16" [1402]	5'-3" [1600]
ROUGH OPENING R	4'-3 31/32" [1320]	4'-11 49/64" [1518]	5'-7 9/16" [1716]
FINISH WIDTH F	4'-2" [1270]	4'-9 13/16" [1468]	5'-5 9/16" [1666]
HANDRAIL TO HANDRAIL H	3'-1 3/16" [944]	3'-8 15/16" [1142]	4'-4 3/4" [1340]

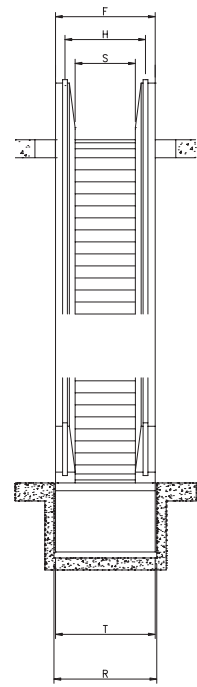

Notes

- (1) Details represent standard KONE escalator configurations. Please consult your Sales Professional to review all possible deviations.
- (2) For detailed options and dimensional design data, please contact a KONE Professional.

Visit kone.us for the latest project-specific details, electrical data, reaction loads, architectural toolbox and building access requirements.

*All drawings are for illustration purposes only.

KONE TRANSITMASTER™ 165/185 AUTOWALKS

Public Transportation Autowalk Product

Well designed and manufactured autowalks are a must for today's highly demanding public areas.

They are key to ensuring the smooth, efficient and safe flow of people traveling in airport environments. We offer two different types of solutions for your facility.



The main benefits of KONE TransitMaster 165/185

- Safety and reliability
- High quality in terms of technical performance and visual appearance
- Optimized total cost of ownership
- Flexible offering to cover the wide range of needs of the segment
- Elegant, modern and harmonized design

Main Characteristics of the TransitMaster 165/185

	TransitMaster 165	TransitMaster 185
Inclination	Maximum 6°	Maximum 6°
Maximum length	196.85 ft (60m)	328.08 ft (100m)**
Speed	0.4m/s with inverter, 0.5m/s, 0.65m/s, 0.75m/s	0.4m/s with inverter, 0.5m/s, 0.65m/s, 0.75m/s
Pallet width	3' 3 3/8" (1000 mm)	3' 3 3/8" (1000 mm)
	3' 11 1/4" (1200 mm)	3' 11 1/4" (1200 mm)
	4' 7 1/8" (1400 mm)	4' 7 1/8" (1400 mm)
Balustrade type	Glass, solid inclined	Glass, solid inclined
Balustrade height	3' 3 3/8" (1000 mm)	3' 3 3/8" (1000 mm)
Handrail type	C-type	C- and V-type
Pallet chains	Inside roller chains	Outside roller chains
Operational environment	Indoor, semi-outdoor	Indoor, semi-outdoor
Duty cycle	20 – 24 hours/day***	20 – 24 hours/day***

** Longer units are available via order engineering. Please contact KONE for more information. *** 24 hours duty cycle is possible with additional maintenance.

KONE ECOMOD®

New escalators the quick and easy way

KONE offers a complete escalator modernization solution without the expense and disruption of removing the existing truss. KONE EcoMod delivers brand new escalator technology without the need to demolish floors, roofs and building façades, and there's always an escalator available for passengers. KONE EcoMod is designed to be compatible with both KONE escalators and equipment from other manufacturers. During modernization we can maintain continuous people flow through the ability to keep one escalator running while we work on the other.

New technology = better escalators

- Improved equipment dependability and performance
- Enhanced safety and reliability
- Energy-efficient technology to help lower operating costs
- Improved user experience with smoother rides
- Potential to increase building value

It's wise to modernize

KONE EcoMod installation advantages

- Quicker, cleaner and less costly than a new installation
- Modifying the existing truss means no major structural modifications
- Reuse of existing cladding and decking for significant cost-savings
- One or more escalators always available to passengers
- Increased building value and simplified budgeting process

Traditional installation disadvantages

- Lengthy process with extensive construction
- Substantial general contractor costs for work by others
- Additional time for removal and prep of structural and related elements
- Complete escalator shutdown during construction
- Major disruption to people flow

Note

(1) For additional information please contact your KONE Sales Professional.

Efficient installation

A KONE EcoMod complete escalator modernization begins with the removal of all existing mechanical and electrical components. The existing truss is then modified to accept KONE EcoMod modules, allowing quick installation of the latest technology without major disruption.

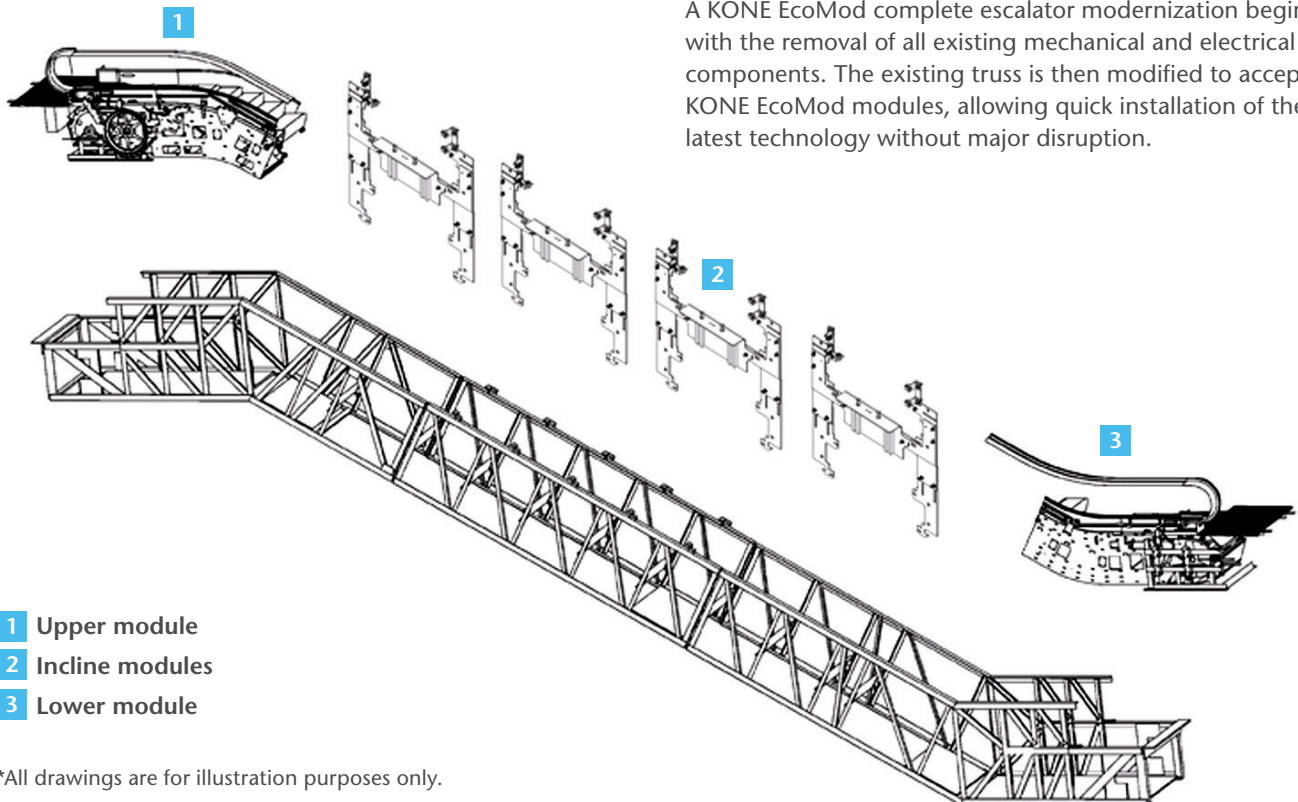

*All drawings are for illustration purposes only.



KONE provides innovative and eco-efficient solutions for elevators, escalators and the systems that integrate them with today's intelligent buildings.

We support our customers every step of the way: from design, manufacturing and installation to maintenance and modernization. KONE is a global leader in helping our customers manage the smooth flow of people and goods throughout their buildings.

Our commitment to customers is present in all KONE solutions. This makes us a reliable partner throughout the life cycle of the building. We challenge the conventional wisdom of the industry. We are fast, flexible, and we have a well-deserved reputation as a technology leader, with such innovations as KONE MonoSpace® DX, KONE EcoMod® and KONE UltraRope®.

KONE employs over 60,000 dedicated experts to serve you globally and locally.

KONE
kone.us